



ANALYZER OF THE QUALITY OF ELECTRIC POWER SUPPLY

QNA-303

(Code 771 131 / 771 132 / 771 133)

USER'S MANUAL

(M 981552 / 02 A)

(c) CIRCUTOR S.A.

QNA-303 MANUAL CONTENTS page

| | | |
|-----------|---|----|
| 1.- | BASIC INSTRUCTIONS | 3 |
| 1.1.- | Checking the contents of your package..... | 3 |
| 1.2.- | QNA-303 Models | 3 |
| 1.3.- | Safety warnings | 4 |
| 1.4.- | Operation instructions..... | 4 |
| 2.- | MAIN FEATURES..... | 5 |
| 2.1.- | Basic features..... | 5 |
| 2.2.- | Electrical features | 6 |
| 3.- | ANALYSIS MODES..... | 7 |
| 3.1.- | Instantaneous values of L1, L2 & L3 (4-wire connection) | 7 |
| 3.2.- | Instantaneous values of L1, L2 & L3 (3-wire connection) | 7 |
| 4.- | DATA COLLECTION IN MEMORY (AUTOMATIC MODE) | 8 |
| 5.- | INSTALLATION & STARTUP | 9 |
| 5.1.- | Selecting the connection mode..... | 9 |
| 5.1.1.- | Selecting the connection mode (3 wires / 4 wires) | 10 |
| 5.1.2.- | Selecting the supply voltage | 10 |
| 5.2.- | Connection cables | 11 |
| 5.3.- | Starting the QNA-303 analyzer up..... | 13 |
| 5.4.- | Connection diagrams of the QNA-303 analyzer | 14 |
| 5.4.1.- | Direct connection..... | 14 |
| 5.4.1.1.- | Connection diagram for L.V. 4-wire power systems | 14 |
| 5.4.1.2.- | Connection diagram for 3-wire power systems..... | 15 |
| 5.4.2.- | Through voltage transformers: | 16 |
| 5.4.2.1.- | Two voltage transformers | 16 |
| 5.4.2.2.- | Three voltage transformers..... | 17 |
| 5.5.- | On-board battery of the QNA-303 analyzer | 18 |
| 6.- | SETTING THE QNA-303 UP | 18 |
| 6.1.- | Operation setup of the QNA-303 analyzer..... | 19 |
| 6.1.1.- | Transformation ratios of voltage transformers | 19 |

- 6.1.2.- Features of the monitored electrical network..... 19
- 6.1.3.- Data collection process features 19
- 6.1.4.- Statistical processing..... 21
- 6.1.5.- Quality parameters 22
- 6.2.- Choosing the parameters to be recorded 23
 - 6.2.1.- Standard File (STD)..... 23
 - 6.2.2.- Events file (EVQ)..... 24
 - 6.2.3.- Incidents file (EVE)..... 25
- 7.- QNA-303 COMMUNICATIONS 26
 - 7.1.- Demand format..... 26
 - 7.2.- Commands 27
 - 7.2.1.- Setup commands 27
 - 7.2.2.- Commands for parameter readout 28
 - 7.2.3.- File managing commands 28
 - 7.3.- Connections of communication cables 29
- 8.- TECHNICAL SPECIFICATIONS 31
- 9.- SAFETY CONSIDERATIONS 33
- 10.- MAINTENANCE 33
- 11.- TECHNICAL SERVICE..... 33

1.- BASIC INSTRUCTIONS

This manual is aimed to familiarize the user with the operation of the power supply quality analyzer model **QNA-303** in order to get the best from its features.

The **QNA-303** is an analyzer expressly developed for the supervision of the quality of electric power supply, which has been built with components incorporating the most advanced technology in microelectronics, and offer benchtop features for the market in terms of measuring and recording of electrical magnitudes in industrial power supply networks.

You are kindly requested to **carefully read this manual before connecting and powering the analyzer** in order to avoid irreversible damage which might be caused by an improper utilization.

1.1.- Checking the contents of your package

After receiving the analyzer, please check the following points:

- a) The delivered material meets your order specifications.
- b) After unpacking, check that the instrument has not been damaged in transit.
- c) The standard set includes the following items:
 - 1 7-pin female connector.
 - 1 4-pin female connector.
 - 1 9-pin female connector.
 - 1 female DB9 connector.
 - 1 User's guide for the **QNA-303**.
 - 1 User's guide for the Software.
 - 1 CD containing the software for PC.
 - 1 GSM antenna (only for the GSM model).

1.2.- QNA-303 Models

| Code | Model |
|---------|---------------------------------------|
| 771 131 | QNA-303 RS-232/RS-485 |
| 771 133 | QNA-303 GSM (Free – SIM not included) |

1.3.- Safety warnings

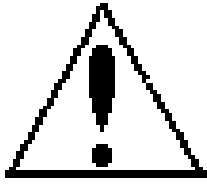

The manual you hold in your hands contains information and warnings about the **QNA-303** that the user should respect in order to guarantee a proper operation of all the instrument functions and keep its safety conditions.

If the instrument is not used as manufacturer's specifications, the protection of the instrument can be damaged.

When any protection failure is suspected to exist (for example, it presents external visible damages), the instrument must be immediately powered OFF. In this case contact a qualified service representative.

1.4.- Operation instructions

The **QNA-303** is a programmable instrument, so offering diverse operation modes which can be selected from the available programming menus.

Please, before initiating works with the **QNA-303**, thoughtfully read the paragraphs involving **INSTALLATION & STARTUP AND SETTING THE QNA-303 UP**, in order to select the most suitable operation mode for your requirements.

Note that with the instrument powered on, the terminals could be dangerous to touching, and cover opening actions or elements removal may allow the access to dangerous parts. Therefore, the instrument must not be used until this is completely installed.

2.- MAIN FEATURES

The **QNA-303** is an analyzer expressly developed for the supervision of the quality of electric power supply. Among their main characteristics, we can remark following:

- High protection level against severe electrical conditions:
 - Wide range of both supply and measuring voltages.
 - High protection level against overvoltage and transient events.
- Connection to either 3 or 4-wire distribution systems.
- Inner battery which permits the instrument to go on recording works even in case of supply voltage loss.
- Inner memory for saving all parameters measured by the **QNA-303**.
- Communication via GSM / RADIO / RS-232 / RS-485 (according to the model).
- IP-55 rated instrument. High protection against adverse environmental conditions.

2.1.- Basic features

The **QNA-303** series analyzer is an instrument specially designed for the analysis of the electric power quality, for that reason, it only provides voltage inputs (isolated by means of transformers).

Moreover, the great variety of available models makes the **QNA-303** suitable for any situation and communication mode.

The inner battery of the instrument assures the continuity of the measuring process by the **QNA-303** in case of any supply voltage loss event (short or long-term line interruption).

The **QNA-303** is equipped with three A.C. voltage inputs which permit a simultaneous measurement of the **voltage** from all three phases, together with the **frequency**, in any power system.

To perform the analysis of the quality of the electric power supply, the **QNA-303** will analyze all cycles from all three voltage phases to detect the occurrence of any event (voltage dip, voltage swell, short and long line interruptions,...).

QNA-303 analyzers are equipped with an **on-board memory (1 Mb or 3 Mb according to the model)** for the collection of quality parameters as well as events.

The different information recorded by the **QNA-303** into its on-board memory is distributed between three file types:

- *.STD files: This file contains all values which are periodically recorded (voltage, frequency, voltage harmonic distortion and the harmonic content).
- *.EVE files: File which contains all incidents referred to the **QNA-303** itself (file readout, setup modification, memory erasure, power supply on/off, battery on/off...).
- *.EVQ: This file contains all events observed in the electric power supply (voltage dips, voltage swells, interruptions) together with some supplementary information about these events (instant of the event occurrence, maximum/minimum voltage, average voltage,...).

2.2.- Electrical features

The application of the **QNA-303** as a recording instrument for the evaluation of the quality of the electrical power supply implies the need that this analyzer must deliver a high protection degree against severe electrical conditions:

- Protective devices in voltage inputs: Special type fuses able to withstand short-term pulses, which considerably increases the instrument efficiency.
- High-energy varistors for the absorption of surges in order to avoid possible costly repairs.
- Noise filters in voltage and current inputs to assure reliable measurements even under most adverse operation conditions.
- Power supply: transformers with an over power dissipation and insulation.
- Power supply by built-in battery to assure a voltage supply to the **QNA-303** in case of voltage loss failure.
- Insulation transformers to guarantee the proper insulation of inputs.
- Enclosure: The case made of aluminium casting provides a great mechanical toughness, but also an exceptional shield against external electromagnetic fields which might appear in extreme situations. Logical and measuring boards are placed inside a separated zone which even increases the screening of sensitive components by "Faraday's cage" effect.

3.- ANALYSIS MODES

QNA-303 series analyzers can perform under different operation modes according to the previous setting.

Most remarkable operation settings are these following:

- Measurement and collection in memory of main power quality parameters (voltage values, flicker and harmonics).
- Setting of a voltage threshold to define diverse event occurrences (voltage sags, voltage swells and interruptions). Also an optional setting of a hysteresis value for each individual threshold.
- The **QNA-303** can perform quality analysis either over 3-wire or 4-wire distribution systems. In accordance to the choice, all quality measurement will be referred to the line-to-neutral or line-to-line voltage..

3.1.- Instantaneous values of L1, L2 & L3 (4-wire connection)

- Line-to-neutral VOLTAGE of every phase, RMS value: V_1, V_2, V_3 .

$$V_n = V_{rms} = \sqrt{\frac{1}{T} \int u(t)^2 \cdot dt} \quad ; \quad V_{rms} = \sqrt{\frac{1}{N} \sum_1^N (U)^2}$$

- FREQUENCY: F (Hz) Measured over L1 voltage phase.

3.2.- Instantaneous values of L1, L2 & L3 (3-wire connection)

- Line-to-line VOLTAGE of every phase, RMS value: V_{12}, V_{23}, V_{31} .

$$V_n = V_{rms} = \sqrt{\frac{1}{T} \int u(t)^2 \cdot dt} \quad ; \quad V_{rms} = \sqrt{\frac{1}{N} \sum_1^N (U)^2}$$

- FREQUENCY: F (Hz) Measured over L1 voltage phase.

4.- DATA COLLECTION IN MEMORY (AUTOMATIC MODE)

The **QNA-303** is equipped with an internal clock for both date and time that permits the automatic data recording process in memory to be set (available capacity according to the model) at regular time periods.

So, the different information recorded by the **QNA-303** into its on-board memory is distributed between three file types:

- *.STD files: This file contains all values which are periodically recorded (voltage, frequency, voltage harmonic distortion and the harmonic content).
- *.EVE files: File which contains all incidents referred to the **QNA-303** itself (file readout, setup modification, memory erasure, power supply on/off, battery on/off...).
- *.EVQ: This file contains all events observed in the electric power supply (voltage dips, voltage swells, interruptions) together with some supplementary information about these events (instant of the event occurrence, maximum/minimum voltage, average voltage,...).

The **QNA-303** is equipped with an on-board rotary memory for data collection; which means that once this memory is full, new values overwrite oldest ones. Therefore, if no data is wanted to be lost, data must be retrieved from the memory before oldest values will be overwritten.

5.- INSTALLATION & STARTUP



The manual you hold in your hands contains information and warnings that the user should respect in order to guarantee a proper operation of all the instrument functions and keep its safety conditions.

If the instrument is not used as manufacturer's specifications, the protection of the instrument can be damaged. Notice that with the instrument powered on, the terminals could be dangerous to touching and cover opening actions or elements removal may allow the access to dangerous parts.

When any protection failure is suspected to exist (for example, it presents external visible damages), the instrument must be immediately powered OFF. In this case contact a qualified service representative.

5.1.- Selecting the connection mode

The **QNA-303** is a fully user-configurable instrument in terms of the kind of network to be monitored and the supply voltage of the analyzer.

The **QNA-303** can be indistinctly installed in a three-phase distribution line with neutral conductor (4 wires) or without neutral conductor (3 wires). According to the system, the **QNA-303** voltage supply will have to be also properly selected between 230 V~ or 400 V~, depending on the existence or not of the neutral conductor.

The choice of the voltage supply and the connection mode is carried out by means of some bridges placed inside the **QNA-303** casing. Please always check the appropriate position of this bridges before connecting and powering the **QNA-303**.

Before any adjustment operation is carried out, the QNA-303 must be completely disconnected from any power supply source.

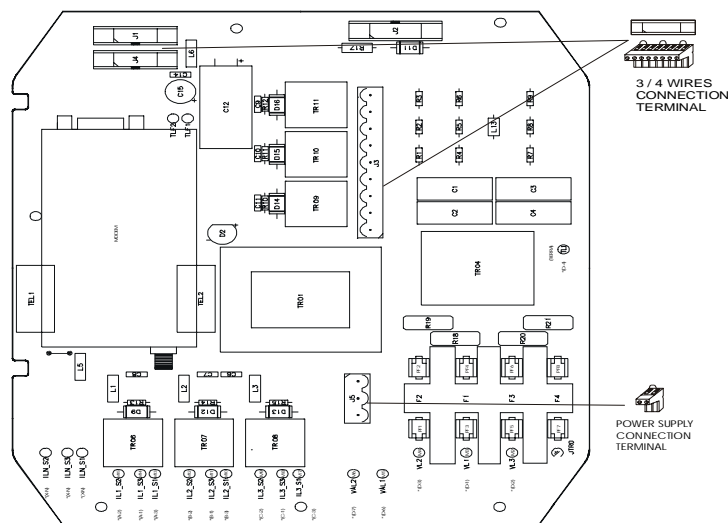



5.1.1.- Selecting the connection mode (3 wires / 4 wires)

The arrangement of the distribution system to be monitored by the **QNA-303** can be selected by means of an inner bridge placed inside the **QNA-303** casing.

Thus, the **QNA-303** will perform the analysis of the voltage incidences according to the position of this bridge, that is, voltage events will be detected between phase and neutral for the 4-wire arrangement, and, on the other side, these events will be detected over line-to-line voltages for the 3-wire arrangement.

To change the position of the bridge, first of all check that the **QNA-303** is completely disconnected from the monitored main (both power supply and measuring circuits), and then remove the frontal cover of the **QNA-303**. Verify that the position of the bridge agrees with the desired system arrangement.

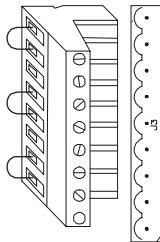
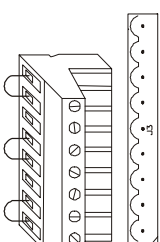
Finally, set also the selected configuration in the PC software, since both settings must always fully coincide.

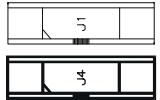
| | 4-wire configuration | | 3-wire configuration: |
|---|--------------------------------|---|----------------------------------|
|  | Connector position: Up |  | Connector position: Down |
|  | Connector position: Up (J1) |  | Connector position: Down (J4) |

5.1.2.- Selecting the supply voltage

The supply voltage of the **QNA-303** for any particular application can be selected by means of an inner bridge placed inside the **QNA-303** casing.

First of all, check that the **QNA-303** is completely disconnected from the monitored main (both power supply and measuring circuits), and then remove the frontal cover of the **QNA-303**. Verify that the position of the bridge agrees with the desired voltage supply.

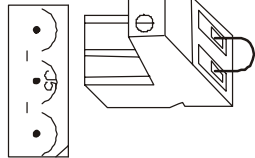
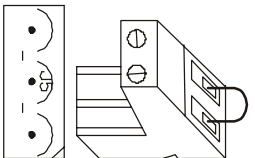
| | | | |
|---|--|--|---|
|  | Power supply: 230 V~ Connector position: Up |  | Power supply: 400 V Connector position: Down |
|---|--|--|---|

5.2.- Connection cables

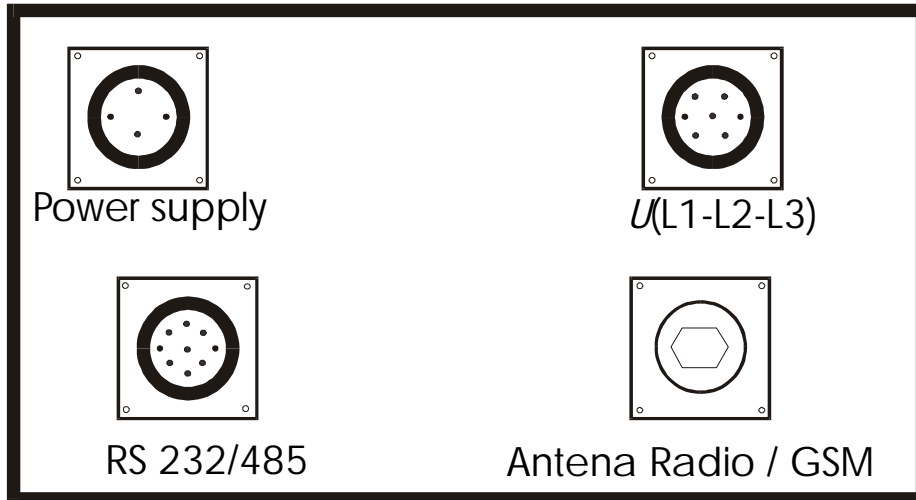

Voltage connector U(L1, L2, L3):

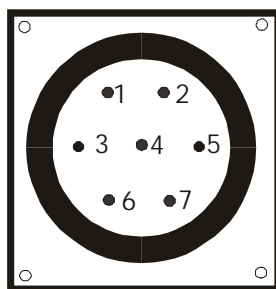

| QNA Pin | Description |
|---------|---------------|
| 1 | Voltage $UL1$ |
| 2 | Voltage $UL2$ |
| 3 | Voltage $UL3$ |
| 5 * | Neutral |

* **Note:** This connection is not required when the monitored distribution system has no neutral conductor

Power supply:

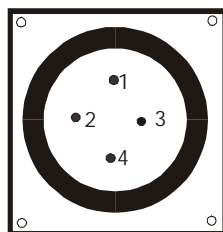

| QNA Pin | Description |
|---------|-------------------|
| 1 | Power supply AL1 |
| 2 | Power supply AL2 |
| 3 | Earthing terminal |

The connection of the earthing terminal is essential to assure the efficiency of QNA-303 protective elements.

RS-232/RS-485 communication connector:

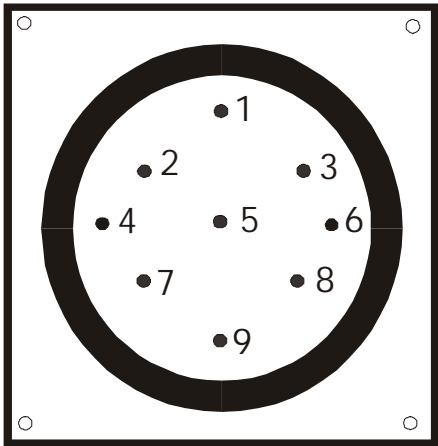

| QNA PIN | Description |
|---------|--------------|
| 1 | RX (RS-232) |
| 2 | CTS (RS-232) |
| 3 | TX (RS-232) |
| 4 | RTS (RS-232) |
| 5 | DSR (RS-232) |
| 6 | GND (Rs-232) |
| 7 | RX (RS-485) |
| 8 | TX (RS-485) |
| 9 | GND (RS-485) |

5.3.- Starting the QNA-303 analyzer up

Before powering the analyzer on please check following points:

1) Supply voltage:

230 V~ +40 % / -40 %, 50... 60 Hz.

400 V~ +40 % / -40 %, 50... 60 Hz.

This choice depends on the position of the inner bridge.

2) Earthing terminal: The earthing terminal of the analyzer must be connected to earth. The lack of this connection implies the inefficiency of some instrument protective elements.

3) Maximum voltage in the voltage measuring circuit:

4-wire arrangement 500 V~ line-to-neutral. / 866 V~ line-to-line.

3-wire arrangement: 500 V~ line-to-line.

4) Analyzer burden: 6 VA.

5) Working conditions:

- Working temperature range: 0 °C to 50 °C.
- Working humidity: 25% to 75 % RH.

6) Safety: Designed to meet protection class III as per EN 61010.

Points to check during the installation process:

7) Verify that the earthing terminal of the **QNA-303** is connected to the earth in order to avoid possible interferences over the analyzer to occur. If this earthing terminal is not connected, then the efficiency of the **QNA-303** protection elements would be reduced.

8) Verify the **QNA-303** setup.

5.4.- Connection diagrams of the QNA-303 analyzer

5.4.1.- Direct connection

5.4.1.1.- Connection diagram for L.V. 4-wire power systems

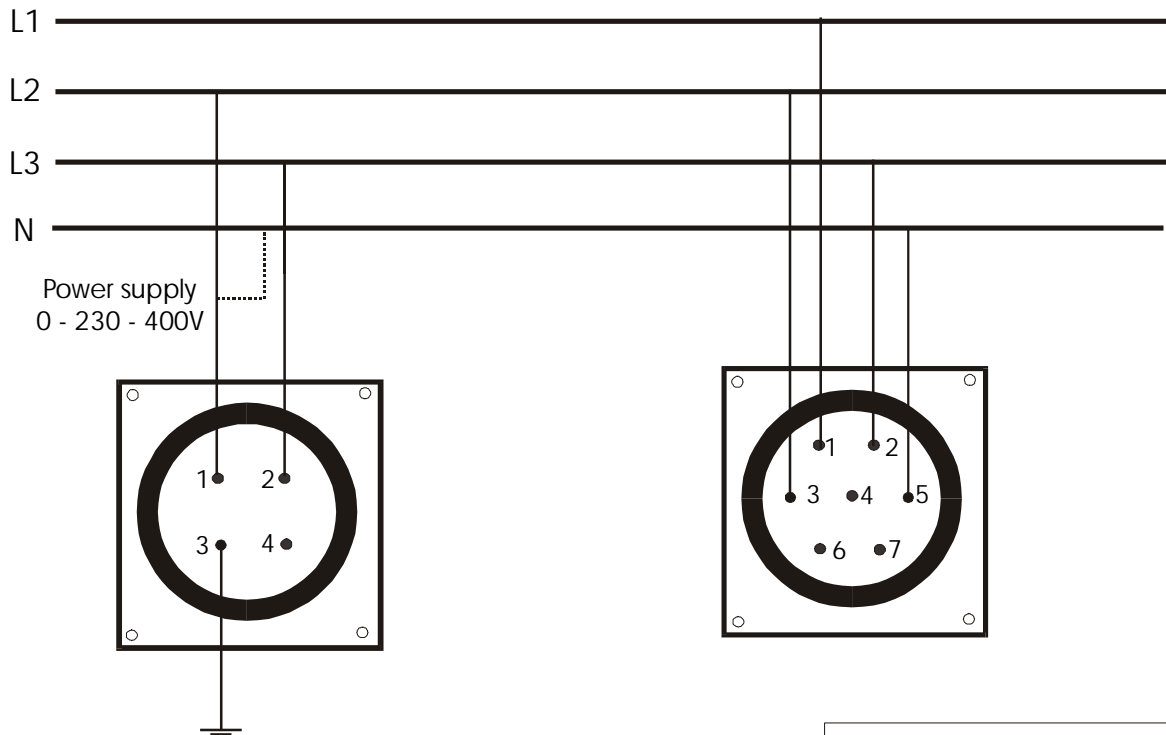

| Voltage connection terminal U(L1, L2, L3) | |
|---|-------------------------|
| QNA Pin | Description |
| 1 | Voltage U _{L1} |
| 2 | Voltage U _{L3} |
| 3 | Voltage U _{L2} |
| 4 | No used |
| 5 | Neutral |
| 6 | No used |

| Power supply connection terminal | |
|----------------------------------|-------------------------|
| QNA Pin | Description |
| 1 | Supply U _{AL1} |
| 2 | Supply U _{AL2} |
| 3 | Earthing terminal |
| 4 | No used |

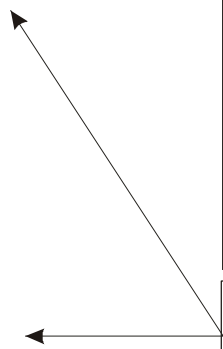
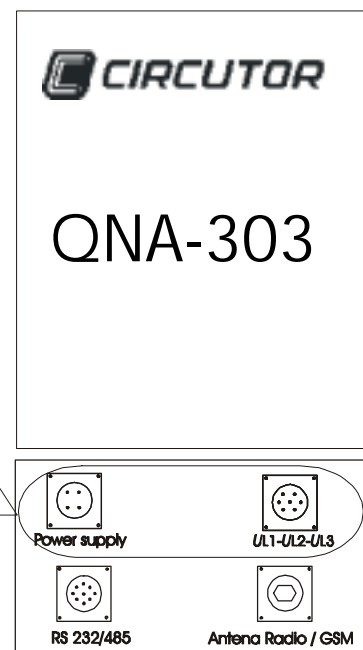

5.4.1.2.- Connection diagram for 3-wire power systems

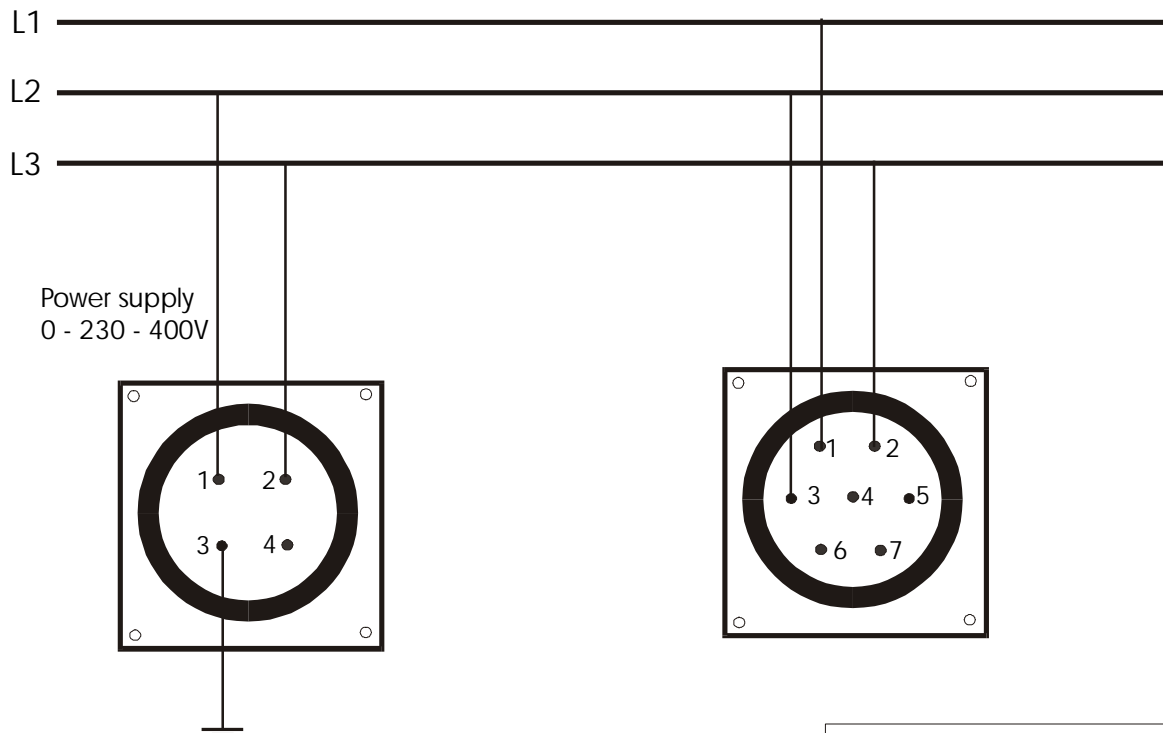

| Voltage connection terminal U (L1, L2, L3) | |
|--|------------------|
| QNA Pin | Description |
| 1 | Voltage U_{L1} |
| 2 | Voltage U_{L3} |
| 3 | Voltage U_{L2} |
| 4 | No used |
| 5 | No used |
| 6 | No used |
| 7 | No used |

| Power supply connection terminal | |
|----------------------------------|-------------------|
| QNA Pin | Description |
| 1 | Supply U_{AL1} |
| 2 | Supply U_{AL2} |
| 3 | Earthing terminal |
| 4 | No used |



5.4.2.- Through voltage transformers:

5.4.2.1.- Two voltage transformers

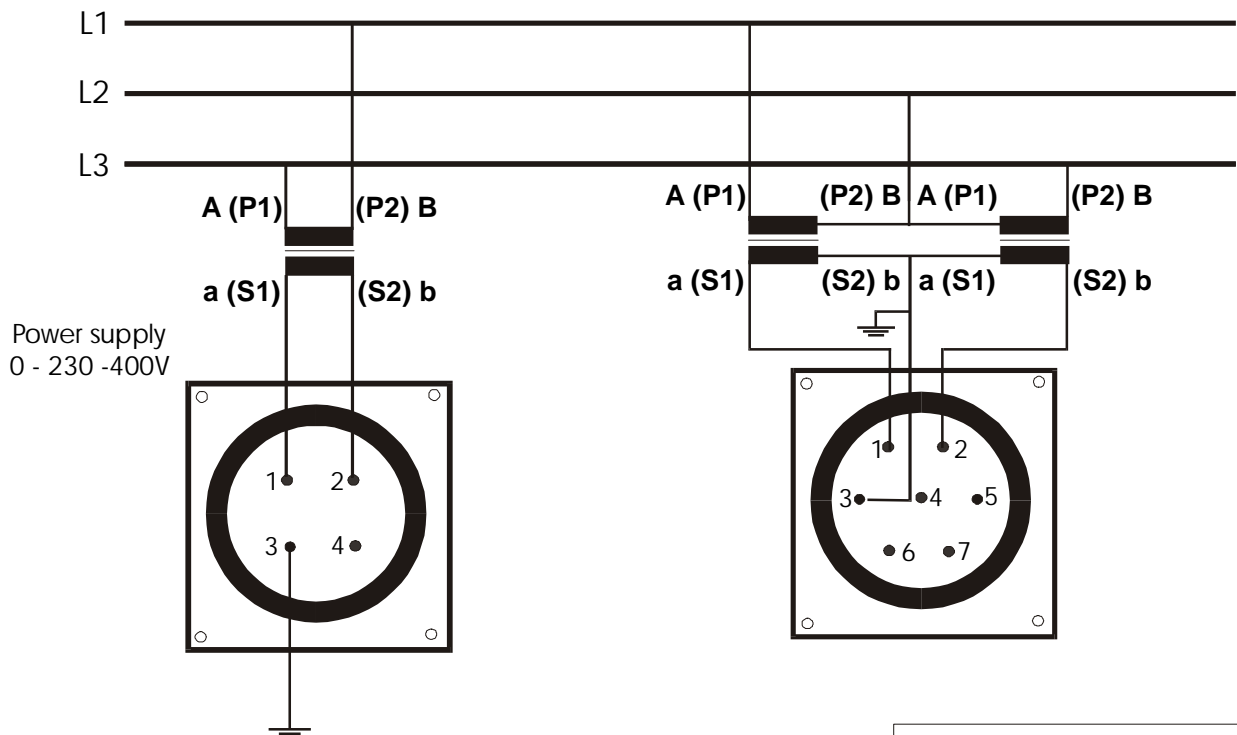

| Voltage connection terminal U (L1, L2, L3) | |
|--|---------------|
| QNA Pin | Description |
| 1 | Voltage $UL1$ |
| 2 | Voltage $UL3$ |
| 3 | Voltage $UL2$ |
| 4 | No used |
| 5 | No used |
| 6 | No used |
| 7 | No used |

| Power supply connection terminal | |
|----------------------------------|-------------------|
| QNA Pin | Description |
| 1 | Supply $UAL1$ |
| 2 | Supply $UAL2$ |
| 3 | Earthing terminal |
| 4 | No used |

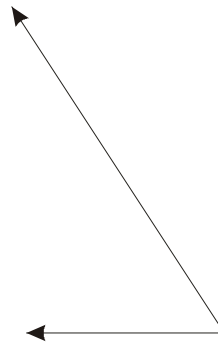
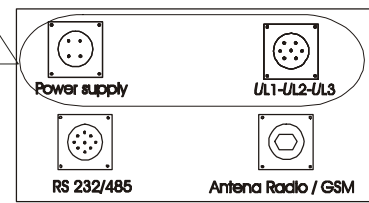
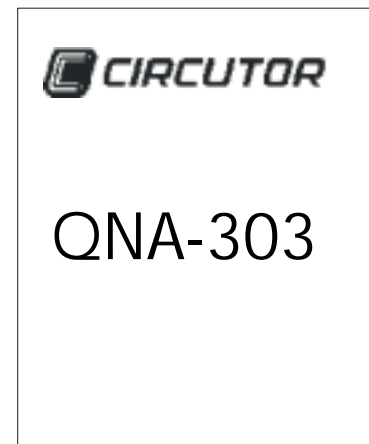

5.4.2.2.- Three voltage transformers

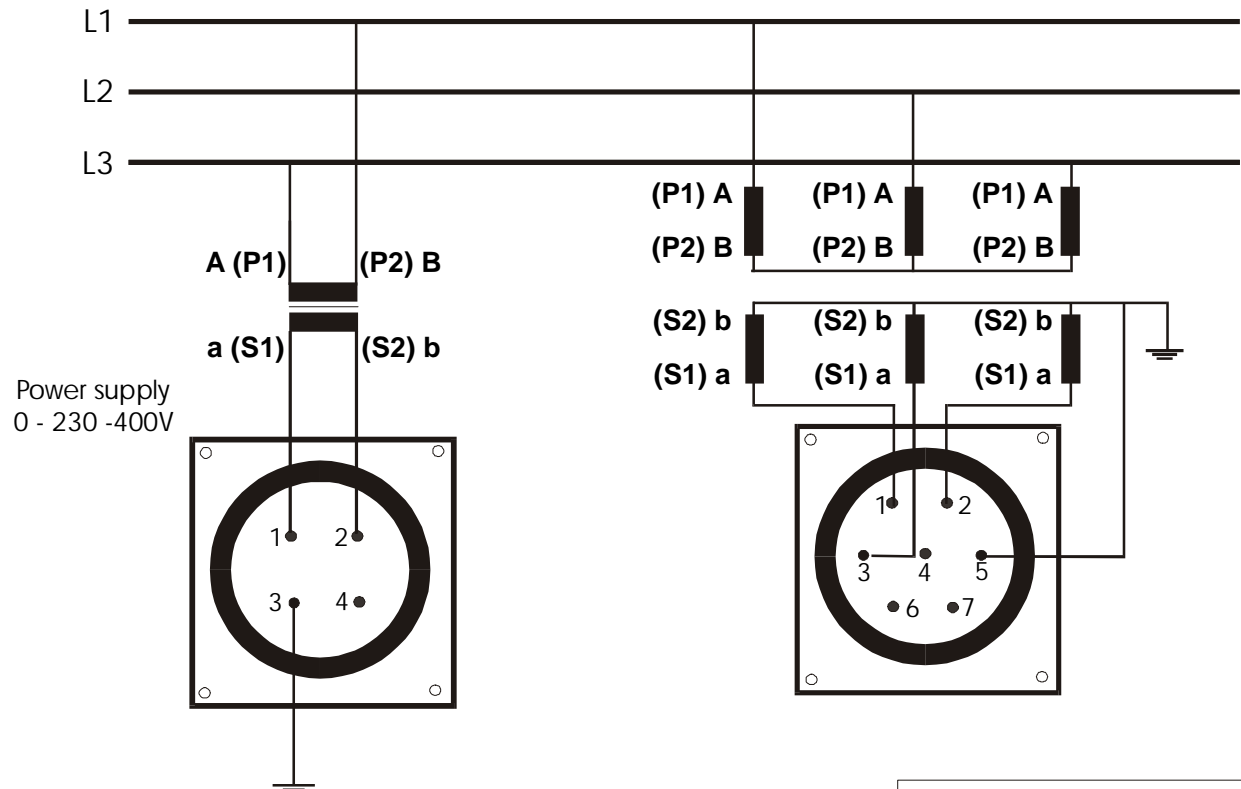

| Voltage connection terminal U (L1, L2, L3) | |
|--|-------------|
| QNA Pin | Description |
| 1 | Voltage UL1 |
| 2 | Voltage UL3 |
| 3 | Voltage UL2 |
| 4 | No used |
| 5 | Neutral |
| 6 | No used |
| 7 | No used |

| Power supply connection terminal | |
|----------------------------------|-------------------|
| QNA Pin | Description |
| 1 | Supply UAL1 |
| 2 | Supply UAL2 |
| 3 | Earthing terminal |
| 4 | No used |

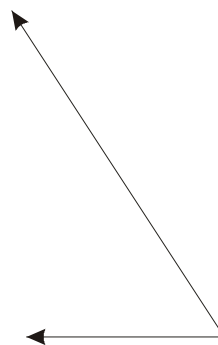
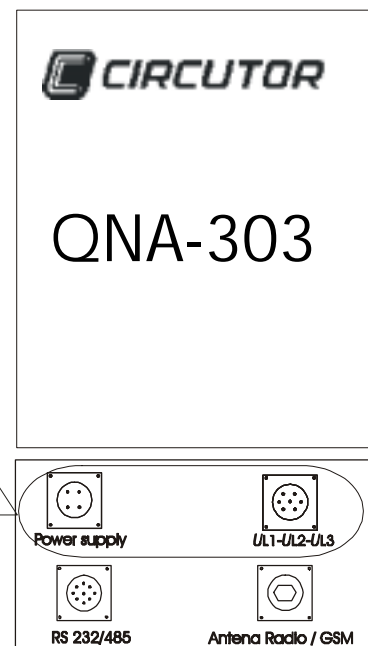

5.5.- On-board battery of the QNA-303 analyzer

The **QNA-303** analyzer is equipped with an intelligent energy charging system. This means that the instrument continuously checks in an automatic way the status of the battery, thus the charging process stops when the battery is at its maximum charge level and, therefore, the life span of the battery is increased.

When the analyzer is connected to the main, the battery is self-recharging.

The analyzer has an inner battery to assure the power supply of the analyzer when any event occurs. This battery permits to keep the analyzer continuously energized during 4 hours in case of lack of voltage supply from the main. This period of time of operation after a voltage supply loss is user-programmable in order to economize the battery charge and to assure the detection of possible intermittent voltage interruptions.

The warranty of a 4-hour operation period is essential to assure the proper detection and recording of multiple and long-term voltage interruptions.

6.- SETTING THE QNA-303 UP

The **QNA-303** analyzer performance will depend on the user-configuration of the instrument. To accomplish this configuration, two different setup sections can be distinguished:

- Operation Setup: To define the **QNA-303** analyzer operation mode.
- File Setup: To define the data collection procedure of the **QNA-303** into the internal memory. (In this model, all parameters are fixed and cannot be user-changed).

6.1.- Operation setup of the QNA-303 analyzer

Points to be user-defined are following:

6.1.1.- Transformation ratios of voltage transformers

The **QNA-303** analyzer can take measurements through voltage transformers.

- **Voltage primary value / Voltage secondary value:** Set the transformation ratio of voltage transformers used for measuring purposes. In case of a direct measurement of the voltage (no voltage transformer used) then just set 1/1.

6.1.2.- Features of the monitored electrical network

- **Rated voltage:** The rated voltage of the power system to be monitored by the **QNA-303**. When the measurement is direct, that is, no voltage transformer is used, then this voltage matches the network rated voltage. If any .../110 V~ voltage transformer is used, then the rated voltage to be set results from the application over the network rated voltage of the transformation ratio. A right configuration of this point is essential since permits setting the limits for the analysis of the electric power supply quality.
- **Rated frequency:** The rated frequency of the power system to be monitored by the **QNA-303**. This parameter is necessary for the calculation of the signal RMS value in extreme quality networks.
- **Measurement type:** The **QNA-303** must be set according to the distribution system to be monitored, whether with neutral conductor (4 wires) or without neutral conductor (3 wires). A proper setting of this point is essential to assure a right detection of event occurrences. This choice must also match the inner bridge position (See section 5.1.1.-)

6.1.3.- Data collection process features

- **File name:** Name of the file to be used for data recording (not modifiable).
- **Recording period:** Integration period for data recording into memory of all selected parameters. Average, maximum and minimum values obtained over this integration period will be recorded (See Section ¡Error! No se encuentra el origen de la referencia.).

- Period of voltage sliding window:** To carry out the calculation of the average, maximum and minimum voltage, the **QNA-303** obtains one value each second. This instantaneous value corresponds to the average of V_{rms} values which have been calculated within the sliding window defined by the user (voltage time constant). If this period is set to 1 s, then the instantaneous value equals the V_{rms} value.

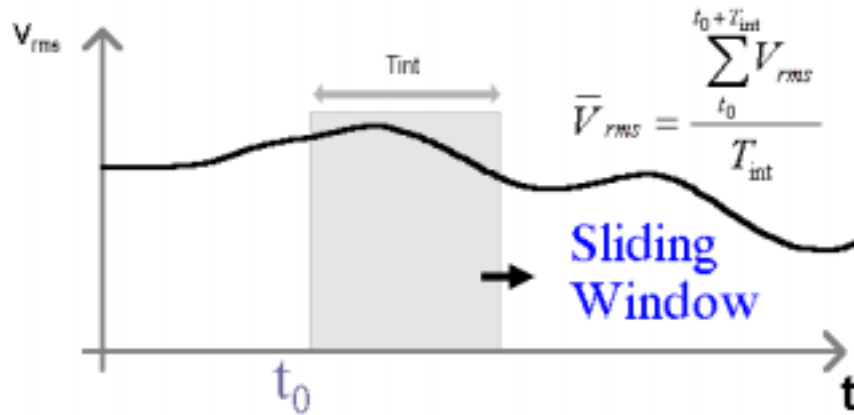

- Period of frequency sliding window:** To carry out the calculation of the average, maximum and minimum frequency, the **QNA-303** obtains one value each second. This instantaneous value corresponds to the average of frequency values which have been calculated within the sliding window defined by the user (frequency time constant). If this period is set to 1 s, then this value equals the instantaneous frequency.

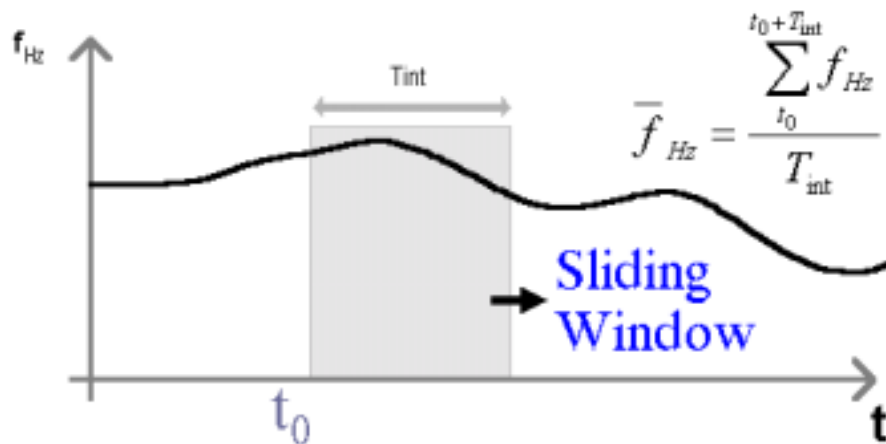

6.1.4.- Statistical processing

- **Confidence level for the voltage (%):** For each record, the analyzer saves in memory a maximum and minimum voltage value within a pre-defined confidence interval. The confidence level (expressed in percentage) indicates the percentage of measures which must be considered for analysis purposes inside the confidence interval, by neglecting extreme values. For instance, if a confidence level of 95 % is set, then the 2.5% of lowest values and the 2.5% of highest values would be neglected. Inside the interval, the maximum and minimum values are obtained and recorded.

If the user want to record the maximum and minimum values taking into account all measurements (absolute values), then a confidence level of 100 % should be set.

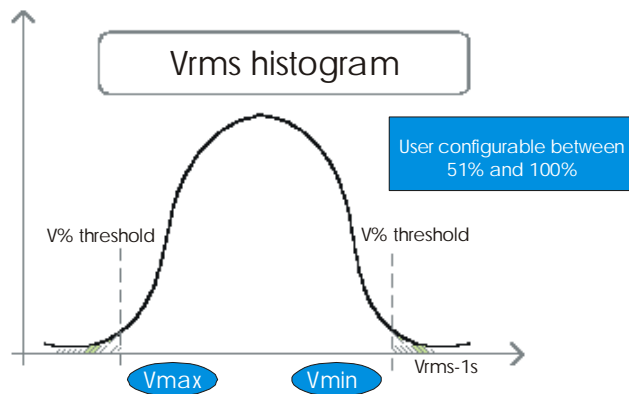

- **Confidence level for the frequency (%):** An analogue processing performed by the **QNA-303** over the voltage can be optionally applied over the frequency. If the user want to record the absolute maximum and minimum values, then a confidence level of 100 % should be set.

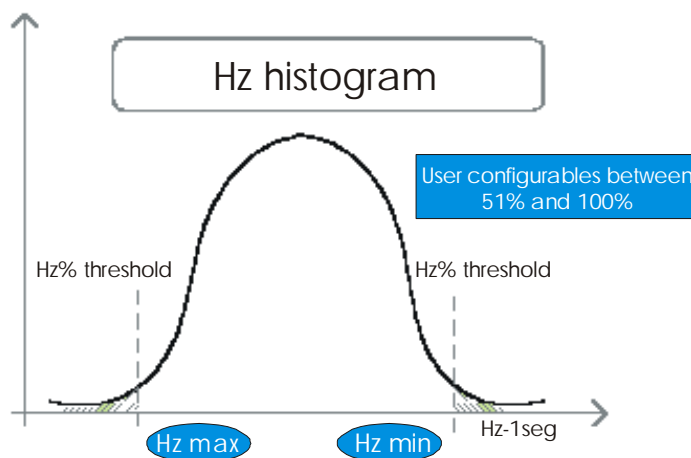

6.1.5.- Quality parameters

- **% of voltage swell threshold:** The detection of a voltage swell depends on the value set in this point (% of the rated voltage). Every semicycle whose RMS value is over the defined limit value is stated to be a voltage swell. A record will be saved into the event file (EVQ) every time this limit value is exceeded, with the indication of the maximum voltage value detected, the voltage average value and the duration of the voltage swell event.
- **Voltage swell hysteresis:** A voltage swell hysteresis value can be defined to set a different value for the voltage swell event starting and ending point. Thus, a voltage swell event starts when the voltage swell threshold is exceeded, and ends when the voltage value is under the value defined by the subtraction of the voltage swell hysteresis value from the voltage swell threshold.
- **% of voltage dip threshold:** The detection of a voltage dip depends on the value set in this point (% of the rated voltage). Every semicycle whose RMS value is below the defined limit value is stated to be a voltage dip. A record will be saved into the event file (EVQ) every time this limit value is exceeded, with the indication of the minimum voltage value detected, the voltage average value and the duration of the voltage dip event.
- **Voltage dip hysteresis:** A voltage dip hysteresis value can be defined to set a different value for the voltage dip event starting and ending point. Thus, a voltage dip event starts when the voltage dip threshold is not reached, and ends when the voltage value is over the value defined by the addition of the voltage dip hysteresis value to the voltage dip threshold.
- **% of interruption threshold:** The detection of an interruption depends on the value set in this point (% of the rated voltage). Every semicycle whose RMS value is below the defined limit value is stated to be an interruption. A record will be saved into the event file (EVQ) every time this limit value is exceeded, with the indication of the minimum voltage value detected, the voltage average value and the duration of the interruption event.

- **Interruption hysteresis:** An interruption hysteresis value can be defined to set a different value for the interruption event starting and ending point. Thus, an interruption event starts when the interruption threshold is not reached, and ends when the voltage value is over the value defined by the addition of the interruption hysteresis value to the interruption threshold.

6.2.- Choosing the parameters to be recorded

The **QNA-303** saves into its on-board memory records of all quality parameters. The different information recorded by the **QNA-303** is distributed between three file types:

6.2.1.- Standard File (STD)

The standard file (STD) is used to store all parameters which are periodically recorded.

Over the user-defined recording period, following electric parameters will be saved into the memory:

➤ Voltage:

- **Average:** voltage average value over the recording period.
- **Maximum (maximum voltage threshold):** voltage maximum value obtained within the recording period. This maximum value is the maximum value obtained within the set confidence level.
- **Minimum:** voltage minimum value obtained within the recording period. This minimum value is the minimum value obtained within the set confidence level.

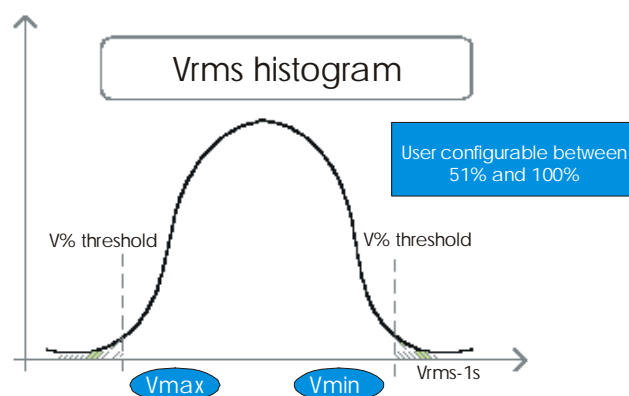

Note: If a confidence level of 100% is set, then obtained values equal absolute maximum and minimum value.

- **Flicker:** The **QNA-303** saves the Flicker value (Pst) obtained over the recording period.

➤ **Harmonics:**

- **Harmonic distortion:** The **QNA-303** will calculate and record into memory the value of the voltage average harmonic distortion detected in the monitored power system.
- **Harmonic content:** The **QNA-303** will calculate and record into memory the average value of the individual harmonic distortion rate of each voltage harmonic in the monitored power system (up to the 25th harmonic)

6.2.2.- Events file (EVQ)

The analyzer also records an events file that contains information on any incidence happening detected in the monitored power system. Following data is saved about each event:

Event date: Indication of the instant of the event occurrence. This value is obtained with an accuracy of one semicycle.

Type of event: Indication of the event type, that is, a voltage dip, a voltage swell or an interruption. These events are defined in accordance to the **QNA-303** setup. (See Section **¡Error! No se encuentra el origen de la referencia.**). The type of event also identifies the phase this event has happened over.

Duration of the event: The number of the semicycles that the event has lasted.

Average voltage of the event: The voltage average value over the event happening period.

Maximum/minimum voltage of the event: In case of an interruption or voltage dip event, the voltage minimum value obtained during the event happening period. In case of a voltage swell even, the maximum values will be recorded.

Previous voltage to the event: The voltage value before the event occurrence is recorded.

6.2.3.- Incidents file (EVE)

All incidents referred to the **QNA-303** itself are automatically saved into this file, with the indication of both the occurrence moment and type. Following incidents can be detected and recorded by the **QNA-303**:

Battery ON: Indication of the moment when the **QNA-303** started to be supplied by its on-board battery.

Battery OFF: Indication of the moment when the **QNA-303** stopped its operation. This moment depends on the value set by the user as the period of time of operation after a voltage supply loss.

Auxiliary power supply ON: Indication of the moment when the **QNA-303** is connected to the external power supply.

Auxiliary power supply OFF: Indication of the moment when the external power supply of the **QNA-303** is interrupted. The analyzer is supplied from this moment by the on-board battery.

Setup modification: Record of the moment when any modification of the instrument setup is realized.

Memory formatting: Indication of the moment when the user has decided the **QNA-303** internal memory to be formatted.

Forced memory formatting: The **QNA-303** internal memory will be automatically formatted if any error in this internal memory is detected.

Delete a file: Indication of the moment when the user has deleted any file from the **QNA-303** internal memory. If the first data shown by the .EVE file is the indication that a file has been delete, then this means that the deleted file was the events file.

Time change: Indication of any change of the date or time of the analyzer's on-board clock. The record of this event type is quite important, since when illogical intervals of time between two successive readouts are observed in the graphical representation of any parameter, this might be due to a change of the time of the on-board clock.

7.- QNA-303 COMMUNICATIONS

One of the main features of the **QNA-303** in terms of communications is the use of the Z-MODEM protocol, both for the data retrieval and the instrument setting actions. This protocol is specially designed for the transmission via modem links. Main features of this protocol are following :

- Full-Duplex protocol which gets the maximum efficiency from the link.
- Automatic adaptation of the baud rate to the phone line quality.
- Automatic adaptation of frame length.
- Complete system of error detection and correction.
- The communication is not cut off in case of punctual errors in frames, but the system tries for several times to resubmit the same information until the verification of a complete communication interruption.

The application of this protocol assures to get optimum data transmission times with a minimum number of incidences.

7.1.- Demand format

PROTOCOL: Question / Answer

The demand format is: **\$PPCCCAA... ch [LF]** (example = **\$00VER71**)

The answer format is: **\$PPAA... ch [LF]**

| | |
|------|---|
| \$ | Any message starts with this symbol (ASCII- 36). |
| PP | The identification code (00) for the portable QNA-303 (decimal-ASCII). |
| CCC | COMMAND. |
| AA | ARGUMENT (Decimal- ASCII). |
| Ch | CHECK-SUM : Check-sum of all the elements forming the message. It is calculated by the decimal addition of all the previous bytes in ASCII and then translating the result into hexadecimal. Two digits are taken. <u>example</u> = \$00RAL --> 36 + 48 + 48 +82 + 65 + 76 = 355 355 decimal or 163 hexad. CHECK-SUM = 63 ----> \$00RAL63 [LF] |
| [LF] | LINE FEED indicates the end of the message (ASCII 10). |

7.2.- Commands

7.2.1.- Setup commands

| COMMAND | CONCEPT | QUESTION | ANSWER |
|------------|--------------------------------------|--|--|
| VER | Read QNA version | \$00VER | \$00 4 digits |
| INI | Reset | \$00INI | \$00ACK |
| RCL | Read date | \$00RCL | \$00XX/XX/XX XX:XX:XX |
| WCL | Write date | \$00WCLXX/XX/XXXX XX:XX:XX | \$00ACK \$00ERR |
| RRT | Read transformation ratios | \$00RRT | \$00 + (6) Primary <i>U</i> + (3) Secondary <i>U</i> + (5) Primary <i>I</i> +(1) Secondary <i>I</i> +(1) 0–III-fase, 1–Aron +(1) 0–3 wire, 1–4 wire |
| WRT | Write transformation ratios | \$00WRT + (6) Primary <i>U</i> + (3) Secondary <i>U</i> + (5) Primary <i>I</i> +(1) Secondary <i>I</i> +(1) 0–III-fase, 1–Aron +(1) 0–3 wire, 1–4 wire | \$00ACK |
| RRS | Read communication parameters | \$00RRS | \$00 + (2) Peripheral number + Parity + Data length + Stop bits + (4) Baud rate + (4) Baud rate COM2 (No used) |
| WRS | Write communication parameters | \$00WRS +(2) Peripheral number + Parity + Data length + Stop bits + (4) Baud rate + (4) baud rate COM2 | \$00ACK |
| RPA | Read recording period and file name | \$00RPA | \$00 + (5) Recording period + (8) File name |
| WPA | Write recording period and file name | \$00WPA + (5) Recording period + (8) File name | \$00ACK |
| RTD | Read battery OFF time | \$00RTD | \$00 (4) OFF time |
| WTD | Read battery OFF time | \$00WTD + (4) OFF time | \$00ACK ch |

7.2.2.- Commands for parameter readout

| COMMAND | CONCEPT | QUESTION | ANSWER |
|------------|----------------------|----------|---------------------------|
| RVQ | Read voltage quality | \$00RVQ | \$00 + (9 x 3) ascii char |

7.2.3.- File managing commands

| COM-MAND | CONCEPT | QUESTION | ANSWER |
|------------|-------------------------------|---|--|
| DIN | Number of files in memory | \$00DIN | \$00 5 digits |
| DIR | Directory of a file in memory | \$00DIR + 5 File number | \$00 + 12 file.ext + 7 bytes no. + 17 date of file creation |
| DEL | Delete a file | \$00DEL + (12) file.ext | \$00FILE NOT FOUND \$00ERR \$00ACK |
| DIF | Consult a file content | \$00DIF + 12 file.ext | \$00 + 12 file.ext + 17 beginning date + 17 ending date + 6 Bytes no. ASCII |
| FOR | Format memory | \$00FOR | \$00ACK \$00ERR |
| SZC | Ask for a file | \$00SZC + file.ext | \$00 + 17 beginning date + 17 ending date → (the QNA starts data transference in ZMODEM) \$00ERR01 → File does not exist |
| SZP | Ask for a part of a file | \$00SZP + 12 file.ext + 17 beginning date + 17 ending date | \$00ACK → (the QNA starts data transference in ZMODEM) \$00ERR00 → QNA in Setup menu \$00ERR → File does not exist or beginning date > ending date |

Note: Date format is “DD/MM/YY hh:mm:ss” with a length of 17 bytes.

7.3.- Connections of communication cables

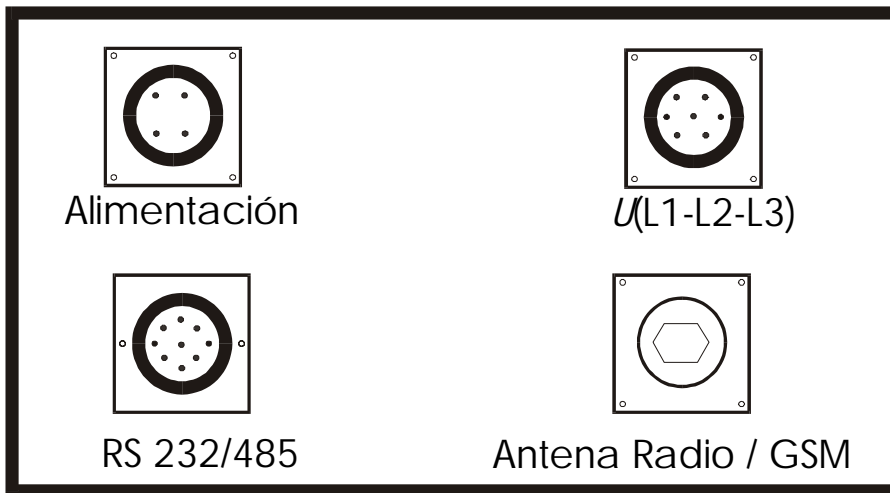

The **QNA-303** analyzer is equipped with a RS communication port to set the communication to the PC. The connection arrangement will depend on the communication mode to be used.

Several communication modes are available according to the **QNA-303** model:

| | GSM | RADIO | 485 | 232 |
|-----------------|-----|-------|-----|-----|
| QNA-303 GSM | X | | X | |
| QNA-303 Radio | | X | X | X |
| QNA-303 232/485 | | | X | X |

QNA-303 units that require a communication cable are only those which will communicate via the RS-232 or RS-485 serial port to the PC. A simultaneous communication via both ports will not be available at any case.

The protocol to be used in **QNA-303 RS-232/RS-485** units will depend on the cable connection arrangement.

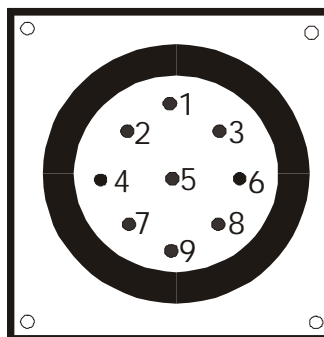

RS 232/485

- Cable for RS-232 communication (PC - **QNA-303**)

| QNA-303 PIN | FEMALE DB9 |
|-------------|------------|
| 1 | 3 |
| 2 | 7 |
| 3 | 2 |
| 4 | 8 |
| 5 | 4 |
| 6 | 5 |

- Cable for RS-485 communication (RS 485 converter - **QNA-303**)

| Converter RS485/RS232 | | | |
|-----------------------|----------------------|--------------------|------------------|
| PIN QNA | DB9 Female RS-485 | DB9 Male RS-232 | DB9 Female PC |
| 7 | 2 | 2 | 3 |
| 8 | 1 | 3 | 2 |
| 9 | 5 | 5 | 5 |
| | | | 7 – 8 |

The **QNA-303 RS-232** can be communicated to a PC via an external modem. This system can be applied in these facilities for which a communication via the conventional phone line is wanted to be set. The communication cable to be used in these cases is different, and also the modem unit must be set to have no control of the DTR and to automatically hold the line on when a call is received. (Consult the user's guide of the modem to be used for any particular application).

- Communication cable for an external modem application

| QNA-303 PIN | MALE DB25 | MALE DB9 |
|-------------|-----------|----------|
| 1 | 3 | 2 |
| 2 | 5 | 8 |
| 3 | 2 | 3 |
| 4 | 4 | 7 |
| 5 | 6 | 4-6 |
| 6 | 7 | 5 |

8.- TECHNICAL SPECIFICATIONS

Power supply:

Supply voltage: Independent from the measuring circuit: 230 or 400 V \pm 40 %
Frequency: 50...60 Hz.
Burden: 6 VA
Working temperature: -10...+50 °C

Auxiliary power supply:

Battery: Ni-M-H
Autonomy: 4 h of continuous operation

Voltage measurement:

Measuring system: 4 wire or 3 wire arrangement (choice by inner connection)

Measuring range: 0 to 500 V~. (line-to-neutral).

4-wire network: 0 to 500 V~ (line-to-neutral).

0 to 866 V~ (line-to-line).

3-wire network: 0 to 500 V~ (line-to-line).

Scale switch: Automatic.

Other voltages: Through voltage transformers.

Frequency : 45 to 65 Hz.

Accuracy:

Voltage: 0.5 % of readout \pm 1 digit.

Measuring conditions to assure accuracy class.:

- Errors due to external voltage transformers not included
 - Temperature range : 5 °C to 45 °C
 - Power factor : 0.5 to 1
 - Measuring range : between 5 % and 100 %
-

Internal memory:

Memory size: 1Mb (3 Mb as optional)

Memory configuration: FIFO

Mechanical characteristics:

Enclosure: IP-55 protection casing

Weight: 2.5 kg

Dimensions:

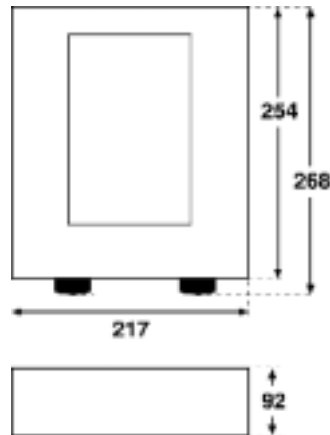

Relevant standardsEN 60664, EN 61010, EN 61036, VDE 110 , UL 94

EM EMISSION

- EN 61000-3-2 (1995), Harmonics.
- EN 61000-3-3 (1995), Voltage fluctuations.
- EN 50081-2 (1993), Industrial emission.
 - EN 55011 (1994): Conducted (EN 55022 - Class B).
 - EN 55011 (1994): Radiated (EN 55022 - Class A).

EM IMMUNITY

- EN 50082-2 (1995), industrial immunity.
 - EN 61000-4-2 (1995), ESD.
 - ENV 50140 (1993), EM Radiated field of RF.
 - EN 61000-4-4 (1995), EFT burst.
 - ENV 50141 (1993), RF common mode.
 - EN 61000-4-8 (1995), 50 Hz H-field
 - EN 50082-1 (1997), Residential immunity.
 - EN 61000-4-5 (1995), Surges.
 - EN 61000-4-11 (1994), Supply voltage interruptions.
-

9.- SAFETY CONSIDERATIONS

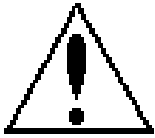

The user should take into account all installation instructions indicated in sections INSTALLATION & STARTUP and TECHNICAL SPECIFICATIONS of this manual.

Notice that with the instrument powered on, the terminals could be dangerous to touching, and cover opening or elements removal actions may allow the access to dangerous parts. The analyzer has been designed and tested to meet IEC 348 standard and is factory-shipped in proper operating conditions.

10.- MAINTENANCE

The **QNA-303** does not require any special maintenance. No adjustment, maintenance or repairing action should be done over the instrument open and powered and, should those actions are essential, high-qualified operators must perform them.

Before any adjustment, replacement, maintenance or repairing operation is carried out, the instrument must be totally disconnected from any power supply source.

When any protection failure is suspected to exist, the instrument must be immediately put out of service. The instrument's design allows a quick replacement in case of any failure.

The design of the analyzer permits its quick replacement in case of failure.

11.- TECHNICAL SERVICE

For any inquiry about the instrument performance or If any failure happens, please contact to CIRCUTOR's technical service.

CIRCUTOR S.A. - After-sales service
Lepanto, 49
08223 - TERRASSA (BARCELONA - SPAIN)
Tel - + 34 93 745 29 00
fax - + 34 93 745 29 14
E-mail : central@circutor.es