



FAST POWER FACTOR REGULATOR

Computer-8df -96

Computer-8df -144

INSTRUCTION MANUAL

(M 981 610 / 99 A)

© CIRCUTOR S.A.

FAST POWER FACTOR REGULATOR COMPUTER- 8 df

1.- POWER FACTOR REGULATORS COMPUTER-8df-96 & COMPUTER-8df-144

The **computer-8df** is a fast response power factor regulator specially designed for the control of thyristor driven capacitors bank. The regulator is provided with static optocoupled outputs (to connect to zero switching control modules - CPC card) . The computer-8df permits the visualization on a digital display of power system $\cos \varphi$, and the automatic connection and disconnection of capacitors in function of this $\cos \varphi$.

Built with a microprocessor and based on the FCP system (FAST Computerized Program), the power factor regulator becomes an intelligent instrument, able to accurately inform about the power system status, and to take complex decisions that most times require a high quantity of calculations. This series compiles the CIRCUTOR's large experience with power factor regulators, so improving their previous features by the application of latest technology.

Main features:

- **True r.m.s. measurements:** The regulator measure the reactive power in the facility, and will connect or disconnect available capacitors according to setup data.
- Regulator with **8 static optocoupled outputs**, with an additional alarm relay.
- Led Display with THREE seven segment digits.
- 4 quadrant, three-phase regulator (single-phase mode user-selectable through internal jumper)
- Setting actions from a frontal keyboard (4 keys).
- Alarms for current harmonic distortion and for improper power factor correction.
- Two sizes as per DIN 43 700 :
 - **COMPUTER-8df-144** : 144 x 144 mm
 - **COMPUTER-8df-96** : 96 x 96 mm

1.2.- Connection instructions



The manual you hold in your hands contains information and warnings about the **Computer 8df** that the user should respect in order to guarantee a proper operation of all the instrument functions and keep its safety conditions.

2.- GENERAL DESCRIPTION

2.1.- VISUALIZATION OF PARAMETERS :

The regulator provides following indications from a frontal panel:

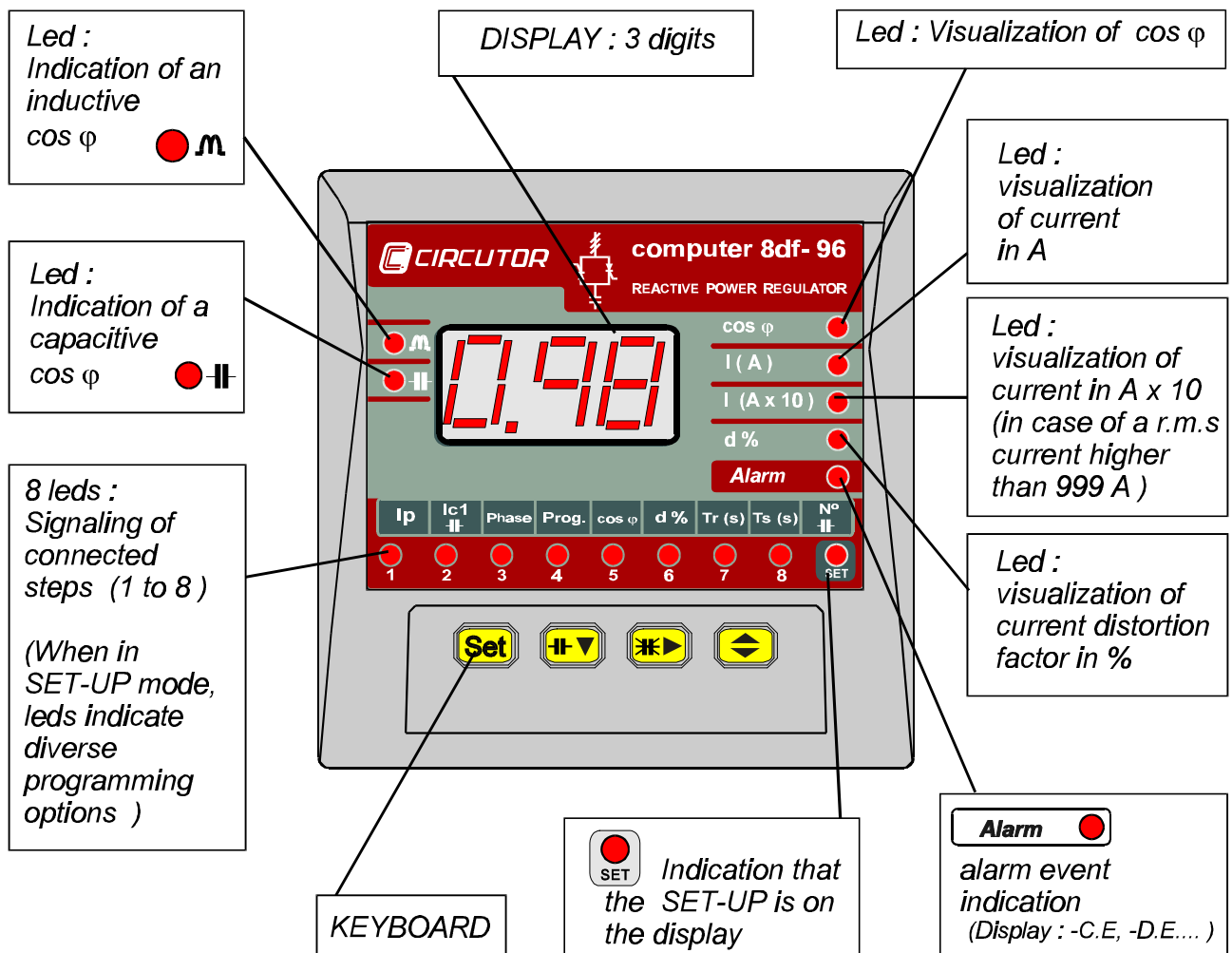

Computer-8df display :

Parameters visualized on this display are:



$\cos \varphi$
 I (A)
 I (A x 10)
 d %
Alarm









- **cos j** : x.xx
- **Current measurement** (in A or in A x 10)
- **Current distortion factor (d %)**

Parameter on display can be switched just pressing the key . 4 leds on the right indicate the parameter shown on display.

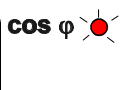
When the last parameter is reached, whether this key is pressed again, the "SCAN" mode is accessed, which provides an automatic and sequential visualization of all parameters (3 s cadence). Pressing it again, the regulator turns back to "normal" mode.

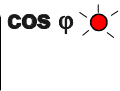
ALARM messages are also displayed (see pertinent section).

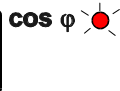
Note : The regulator works at **four quadrant measuring mode**. That way, whether a negative sign is shown at the first digits of the display, it means that the power system is a generator one. Check connection of phases and setup whether the indication is not correct. (**SET-UP - phase**).

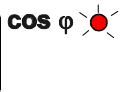





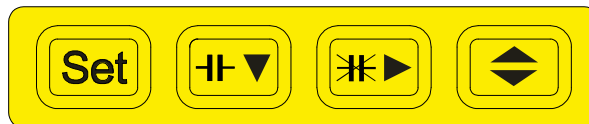

  	$\cos \varphi > 0$ - system consuming energy ex.: 0.96 L inductive (+ kW & kvarL)
  	$\cos \varphi > 0$ - system consuming energy ex.: 0.95 C capacitive (+ kW & kvarC)
  	$\cos \varphi < 0$ - system generating energy ex.: -.85 L inductive (- kW & kvarL)
  	$\cos \varphi < 0$ - system generating energy ex.: -.95 C capacitive (- kW & kvarC)

2.2.- KEYBOARD

The regulator is equipped with following keys on its **frontal panel**:



Diverse functions are assigned to each key according to the operation mode.

	<p>- Pressing the key (SET) the regulator configuration can be visualized, but this cannot be modified (see setup procedure section). Led "SET" is on.</p> <p> The key  permits to access diverse configuration sections.</p> <p> Press the key (SET) again to exit. (whether no key is press for more than 3 minutes, setup visualization is automatically exited).</p> <p><i>Note: during this visualization mode, the regulator continues measuring the power system, and, therefore, connection-disconnection actions are carried out if necessary.</i></p>
 	<p>- These keys permit a MANUAL CONNECTION  / DISCONNECTION  of capacitors. Whether the key is kept press, all capacitors will be sequentially connected/ disconnected according to the defined delay times (Tr (s) & Ts (s)). 20 s later the key is not press anymore, the regulator turns back to automatic operation mode.</p> <p>- <i>Within the SET-UP mode, diverse available configuration options can be selected by repeatedly pressing these keys.</i></p>
	<p>- This key permits to switch the parameter visualized on display: cos j, Current measurement (in A or in A x 10) & Current distortion (d %).</p> <p>- <i>Within the SET-UP mode, use this key to VALIDATE configuration choices.</i></p>

2.3.- USER-PROGRAMMABLE PARAMETERS (SET-UP menu)

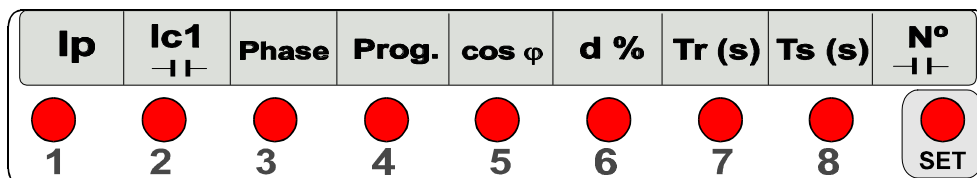

- 1.- Current transformer setting: choice of standard values
- 2.- Rated current of first capacitor (Ic1)
- 3.- Choice of voltage phase
- 4.- Operation program : 5 programs
- 5.- Cos φ: setting : 0.80 L to - 0.95 C
- 6.- Distortion factor setting : 0 999 %
- 7.- Connection time : 0,1 9,99 s
- 8.- Safety time : 0,1....9,99 s
- 9.- Number of output relays : 1.....8

Set-up options description

(1) PRIMARY OF CURRENT TRANSFORMER:

- Select here the current transformer primary (from 5 A to 9990 A) .
- Secondary is fixed (standard ...5 A a.c.)

(2) RATED CURRENT OF FIRST CAPACITOR :

- Set here the rated current of the first capacitor in the bank.
- From this current and the C.T. ratio, the regulator automatically calculated the C/K value.

(3) CONNECTION PHASE SELECTION:

The user can select the configuration of the regulator installation to perform the power factor measurement.

The regulator read the current of one phase (generally through a .../5 A C.T.) and the power system voltage (generally between two phases).

(4) SELECTION OF OPERATION PROGRAM

Available operation programs are:

program 1 ----> 1.1.1.1.1
program 2 ----> 1.2.2.2.2
program 3 ----> 1.2.4.4.4
program 4 ----> 1.2.4.8.8
program 5 ----> 1.1.2.2.2

(5) Cos φ : setting: Programmable from **0.80** Inductive to **0.95** capacitive

(6) DISTORTION FACTOR SETTING d % : 1 999 %

(7) (8) TIMES

- Connection time : from 0,1 s to 9,99 s
- Discharge time (safety time) : from 0,1 s to 9,99 s



When the regulator is powered up, delay time for the connection of the first capacitor is the safety time T_s .

(9) NUMBER OF CAPACITORS: When selecting this option, the number of capacitors selected is shown up on display, as well as related leds are on.

Other points to consider:

- Whether no current is measured (indication 0.00 on display), and any relay is closed, the regulator will automatically open them.
- If a very high capacitive cos φ is measured, all steps are automatically disconnected.



4.- INSTALLATION AND START-UP

The manual you hold in your hands contains information and warnings about the **Computer 8d** that the user should respect in order to guarantee a proper operation of all the instrument functions and keep its safety conditions

The regulator must not be used until its definitive assembly inside the switchgear board.

Whether the instrument is not used as manufacturer's specifications, the protection of the instrument may result damaged.

When any protection failure is suspected to exist (for example, it presents external visible damages), the instrument must be immediately powered off. In this case contact a qualified service.

4.1.- INSTALLING THE REGULATOR

Before powering the regulator up, check following points:

a.- **Supply voltage** : see rear part of your Computer-8df

- Frequency : 45 ... 65 Hz
- Supply tolerance : + 15 % / --15 %
- Connection terminals : 1 - 2 or 1 - 3 (see drawings at the regulator)
- Burden : 5 VA

- b.- Current measurement:
- In/5 A a.c. Current transformer
 - Connection terminals 8 & 9 .

- c.- Working conditions :
- Working temperature : -10° to +50°C
 - Working humidity : 25 to 80 % RH

- d.- Safety : Category III, as per EN 61010.
Protection against electric shock by double isolation system (class II equipment)

4.2.- CONNECTIONS

The regulator is to be mounted on panel (cut out as per DIN 43 700) .

- Computer-8df-96 : cut out $92^{+0.8} \times 92^{+0.8}$ mm.
- Computer-8df-144 : cut out $138^{+1} \times 138^{+1}$ mm.



All connections keep inside the cabinet .

Note that with the instrument powered on, the terminals could be dangerous to touching and cover opening actions or elements removal may allow accessing dangerous parts. Therefore, the instrument must not be used until this is completely installed.



The regulator must be powered from a power source protected with gl type (IEC 269) or M type fuses rated between 0.5 and 2 A. This circuit should be provided with an automatic switch (I/O) or any equivalent element to connect (ON) or disconnect (OFF) the instrument from the power supply network. Power supply circuit as well as connections to different relays will be wired with cables of a minimum cross-section of 2.5 mm^2 . The circuit from de current transformer secondary will be also wired with a cable with a have a minimum cross-section of $2,5 \text{ mm}^2$.

Connect the regulator according to the connection drawing attached at the rear part of the regulator. Take following points into account:

- To start-up the regulator it is necessary to install a current transformer (normally **In / 5 A**) suitable for **the whole current of loads in the facility**. The circuit from the C.T. secondary will be wired with a cable of a cross-section adequate to the distance between the C.T. and the regulator.
- The regulator is powered between **two phases** (except for a single-phase model). **The phase in the power system where the C.T. is placed can or not coincide with any of the phases the regulator is powered from.**

COMPUTER-8d CONNECTION TERMINALS

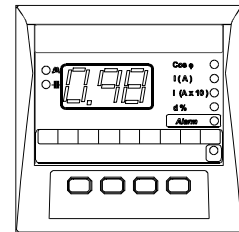
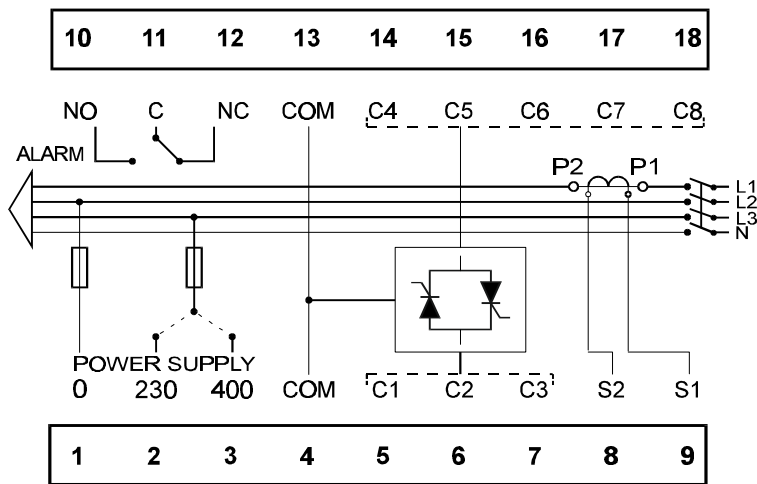

No Terminal description

Lower terminals

- 1 Voltage input 0 V
- 2 Voltage input 230 V a.c.
- 3 Voltage input 400 V a.c.
- 4 Output common C1, C2, C3
- 5 Output 1
- 6 Output 2
- 7 Output 3
- 8 Current input S2
- 9 Current input S1

Upper terminals

- 10 Alarm relay NO
- 11 Alarm relay common
- 12 Alarm relay NC
- 13 Output common C4 to C8
- 14 Output 4
- 15 Output 5
- 16 Output 6
- 17 Output 7
- 18 Output 8

- The C.T. must be placed at any point of the power system entrance where the whole current of the facility, even the own current of capacitors, can be measured.

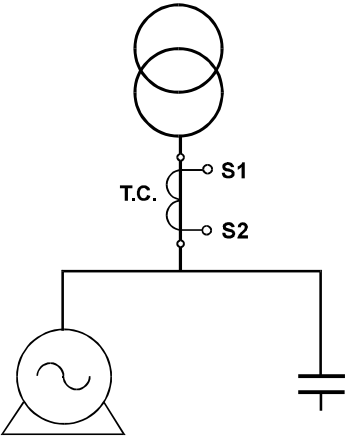
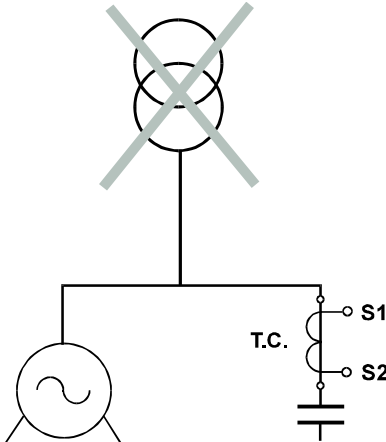
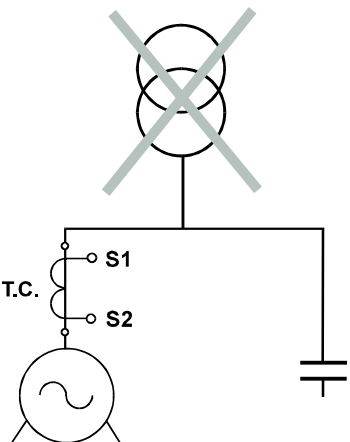
RIGHT	WRONG	
 <p data-bbox="177 1473 568 1576">- The C.T. must be obligatory placed before the capacitor bank and loads (motors, etc).</p>	 <p data-bbox="651 1402 903 1442">Display 0.00</p> <p data-bbox="603 1473 1002 1675">- No capacitor is connected as the C.T. does not provide any signal - Check that the C.T. is not at short-circuit or placed out from load circuit.</p>	 <p data-bbox="1106 1402 1358 1442">Display X.XX</p> <p data-bbox="1026 1473 1433 1682">- All capacitors of the bank are connected, but none will be disconnected when the load falls. The power system may be over-compensated when no load exists.</p>

- Connect the C.T. secondary (S1-S2) to the terminals marked as S1-S2 (9 & 8). Whether the display shows an incoherent value for the $\cos \varphi$., a discrepancy with the set phase relation may exist: access set-up, and then the option "Phase" (see related section) .

- Whether the display shows "**0.00**", no enough current signal is provided to the regulator, and therefore this cannot measure the $\cos \varphi$. In case that loads are in operation, check the circuit coming from the C.T. secondary (this could be open or in short-circuit at any point).

5.- SETTING THE REGULATOR UP





To access **the regulator setup menu** proceed as follows:

- If the regulator is powered on and keys  &  are simultaneously pressed within first five seconds, SET-UP options are accessed and configuration parameters may be modified.





If the process is correctly done, the word "**SET**" is shown on display for some seconds, and the led "**Set**" is on.

You can here access different programming options:

- a.- Use the key  to select the parameter to be programmed.
- b.- Use the key  to confirm the selected parameter.
- c.- Use keys  and  to modify the value shown on display.
- d.- Once modification is finished, press  to exit and validate modifications. General SET-UP menu is again accessed.

Proceed similarly for all programming sections.



Whether more than 5 seconds has passed from the regulator was powered on, no action occurs if keys  &  are pressed.





When pressing the key (**SET**) at any moment, the regulator configuration can be visualized by display, but this cannot be modified. The led "**Set**" is also on for this action.

5.1.- C.T. PRIMARY SETTING:



Set here the value of the current transformer primary (from 5 A to 9990 A).
 For a value fixed between 5 to 999 A, current readout is direct, and from 1000 A, the readout will be the total current divided by ten, and the led I(A x 10) will be on (real value = readout x 10).
 The secondary value is fixed and cannot be programmed (standard ...5 A a.c.).



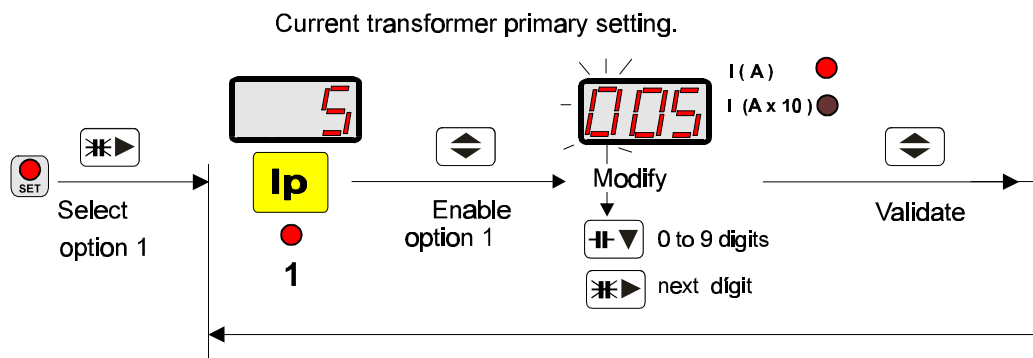

Once in setup mode (the led "set", red coloured, is always on) :

- a.- Use the key  to place at position 1: the led "1" is on
- b.- Use the key  to enable **current transformer primary setting**.



The value of the previously set primary is shown on display, and the first digit blinks.

- c.- Use keys  and  to modify the value on display:

- Repeatedly pressing the key  the value of the blinking digit is increased.
- Press the key  to pass to next digit. When last digit is reached, whether the key  is again pressed, the led " I(A)" or " I(A x 10) " starts to blink, since then pressing the key  the scale can be switched: x 1 (value up to 999 A) or x 10 (value up to 9990 A) .

Note :if the scale "I(Ax 10) is chosen, the value programmed on the screen must be divided by 10

Example: the value 1000 is set as 100 and the led " I(A x 10)" must be on.

(Real value = value on display x 10).

d.- Press  to exit this menu option and to validate modifications General SET-UP menu is again accessed.

5.2.- RATED CURRENT OF FIRST CAPACITOR:

Set here the value of the rated current of the first capacitor in the power factor correction bank (value programmable from 0.01 A to 999 A).

Once in setup mode (the led "set", red coloured, is always on) :

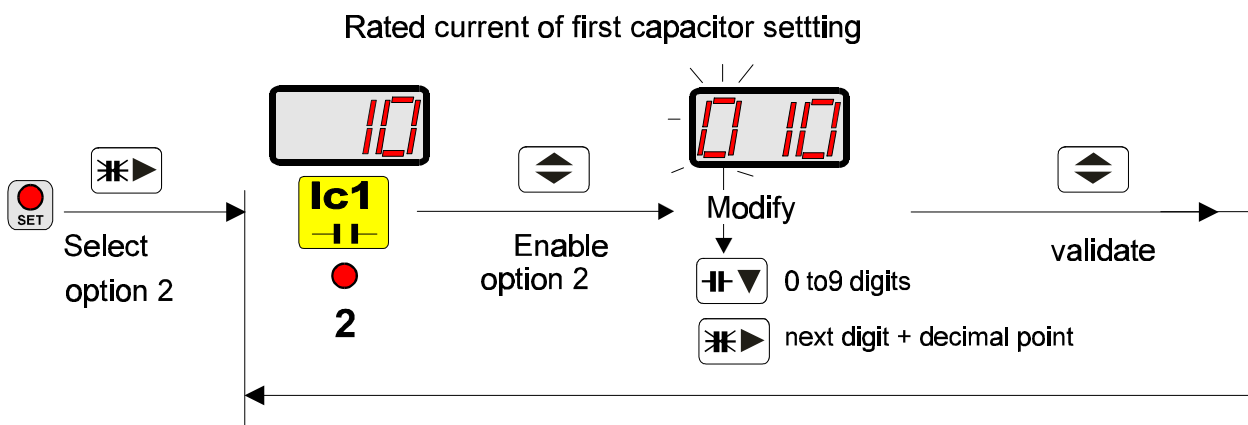

a.- Use the key  to place at position 2: the led "2" is on

b.- Use the key  to enable **rated current of first capacitor setting**.







Note : From this current (2) and the C.T. ratio (1), the regulator automatically calculated the C/K value.

The value of the previously set primary is shown on display, and the first digit blinks.

c.- Use keys  and  to modify the value on display:

- Repeatedly pressing the key  the value of the blinking digit is increased.

- Press the key  to pass to next digit. When last digit is reached, whether the key  is again pressed, the decimal point starts to blink, since then pressing the key  the position of this decimal point can be moved: ($x.xx \rightarrow xx.x \rightarrow xxx. \rightarrow x.xx$)

d.- Press  to exit this menu option and to validate modifications General SET-UP menu is again accessed.



5.3.- CHOICE OF CONNECTION PHASE:

Select here the installation configuration: **the current transformer is placed at one phase and the voltage input is taken between two phases.**

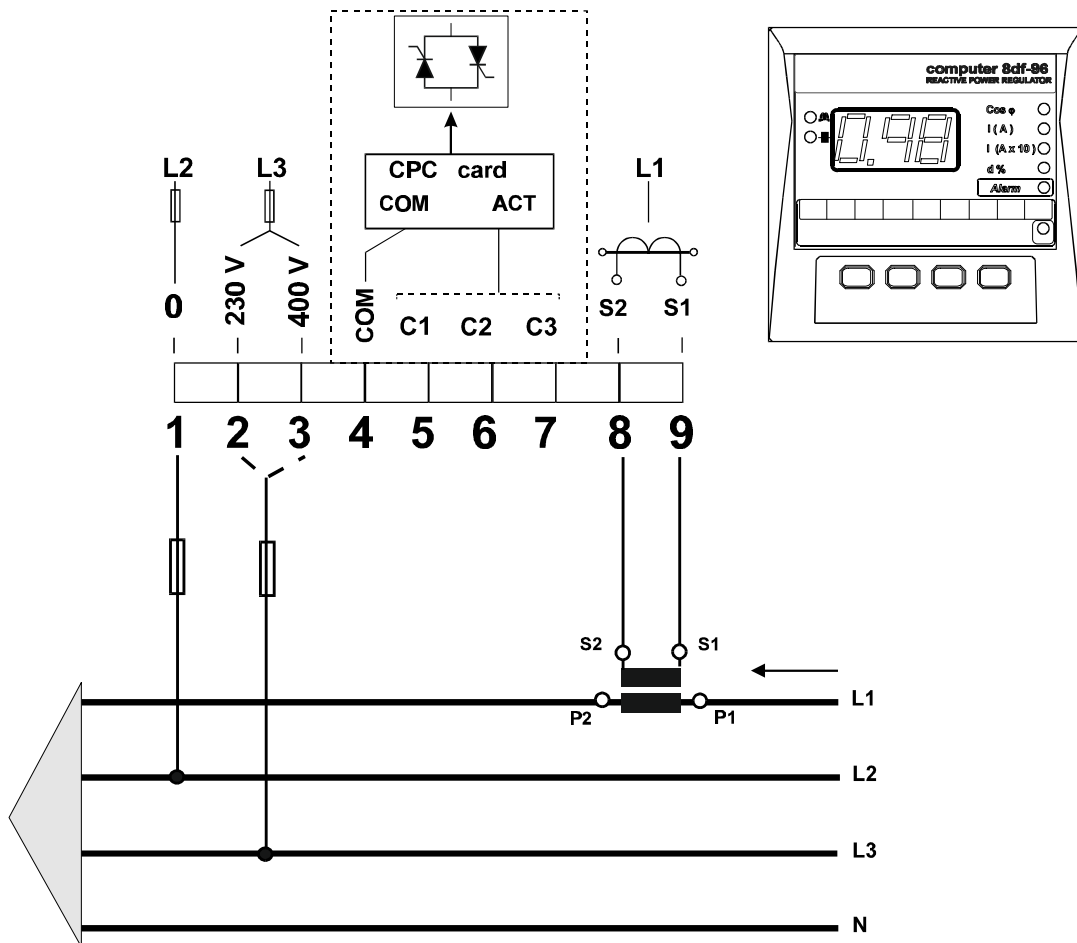
Default configuration is that placing the C.T. at one phase and taking the voltage input between other two left phases (t-2), but other configuration can be set.





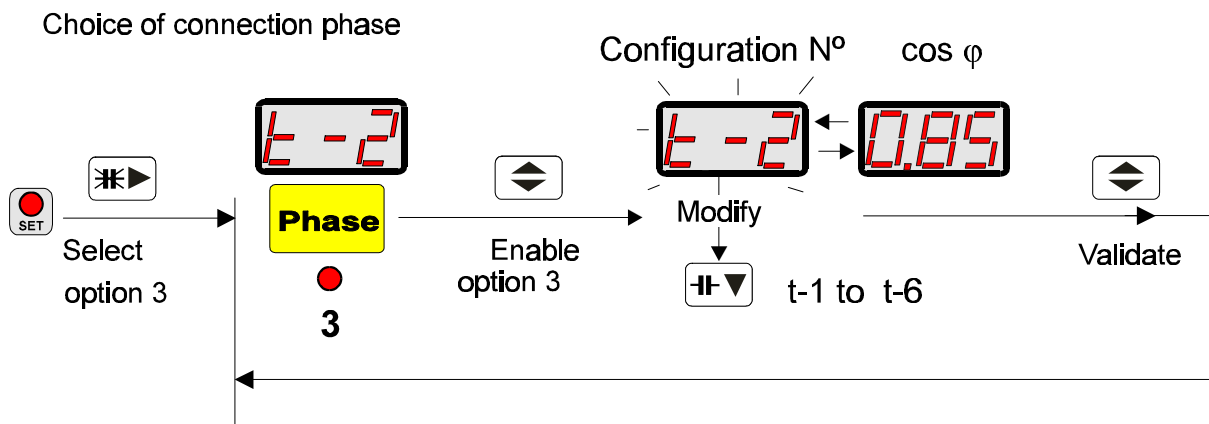

Once in setup mode (the led "set", red coloured, is always on) :

- a.- Use the key  to place at position 3: the led "3" is on
- b.- Use the key  to enable **phase relation setting**.

The previously set choice is shown on display (t-x), and the **cos j** readout in the installation according to the selected connection mode is also automatically shown up.



- c.- Use keys  and  to modify the option on display:

- Repeatedly pressing the key  the connection mode choice is modified. Some seconds later the **cos j** is shown. In case that this value is not a reasonable value press again the key 

t-1	t-2	t-3	t-4	t-5	t-6
CT = L3 VM = L2-L3	CT = L1 MV = L2-L3	CT = L2 VM = L2-L3	CT = L3 VM = L3-L2	CT = L1 VM = L3-L2	CT = L2 VM = L3-L2



- d.- Press  to exit this menu option and to validate modifications General SET-UP menu is again accessed.

Three-phase connection (L1 -L2 -L3): Current signal from one phase and voltage measurement between two phases.

Connection mode	V- I shift angle with $\cos \mathbf{j} =1$	Phase connection	Connection drawing
Direct C.T. t-1	30°	Current = L3 Voltage = L2-L3	
Inverted C.T. t-4	210°	Phase of current coincides with one phase of voltage	
Direct C.T. t-2	90°	Current = L1 Voltage = L2-L3	
Inverted C.T. t-5	270°	Phase of current is none phase of voltage	
Direct C.T. t-3	150°	Current = L2 Voltage = L2-L3	
Inverted C.T. t-6	330°	Phase of current coincides with one phase of voltage	



5.4.- CHOICE OF THE OPERATION PROGRAM

Select here the operation program for the capacitor connection.
Once in setup mode (the led "set", red coloured, is always on) :

- a.- Use the key  to place at position 4: the led "4" is on
- b.- Use the key  to enable **operation mode setting** (relation between capacitors in the automatic bank).

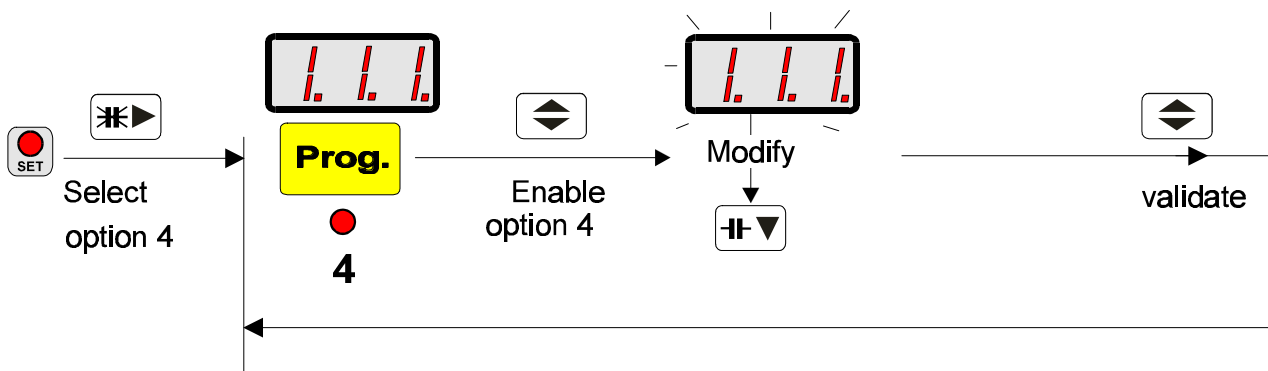
The previously set choice is shown on display:



- c.- Use keys  and  to modify the operation program on display:
- Repeatedly pressing the key  the operation mode choice is modified.

program 1.1.1.1.1 → **1.1.1**
 program 1.2.2.2.2 → **1.2.2**
 program 1.2.4.4.4 → **1.2.4**
 program 1.2.4.8.8 → **2.4.8**
 program 1.1.2.2.2 → **1.1.2**

- d.- Press  to exit this menu option and to validate modifications General SET-UP menu is again accessed.

5.5.- $\cos j$ SETTING:

Use this option to set the $\cos j$ value to be reached at the installation. This is an user-programmable value from **0.80** Inductive to **0.95** capacitive.

Once in setup mode (the led "set", red coloured, is always on) :

a.- Use the key  to place at position 5: the led "5" is on

b.- Use the key  to enable $\cos j$ setting

The previously set choice is shown on display:

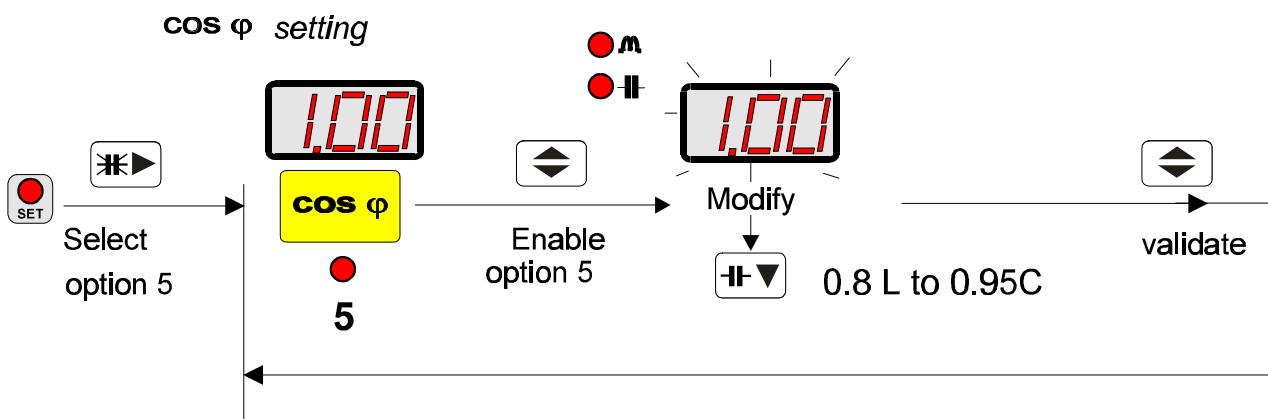

c.- Use keys  and  to modify the operation program on display:

- Repeatedly pressing the key  the $\cos j$ value will vary from 0.85 Inductive to 0.95 capacitive.

d.- Press  to exit this menu option and to validate modifications General SET-UP menu is again accessed.

5.6.- DISTORTION FACTOR d % SETTING

Use this option to set the value for the distortion alarm of the installation. This is an user-programmable value from **1 to 999 %**



Once in setup mode (the led "set", red coloured, is always on) :

a.- Use the key  to place at position 6: the led "6" is on

b.- Use the key  to enable **factor d % setting**

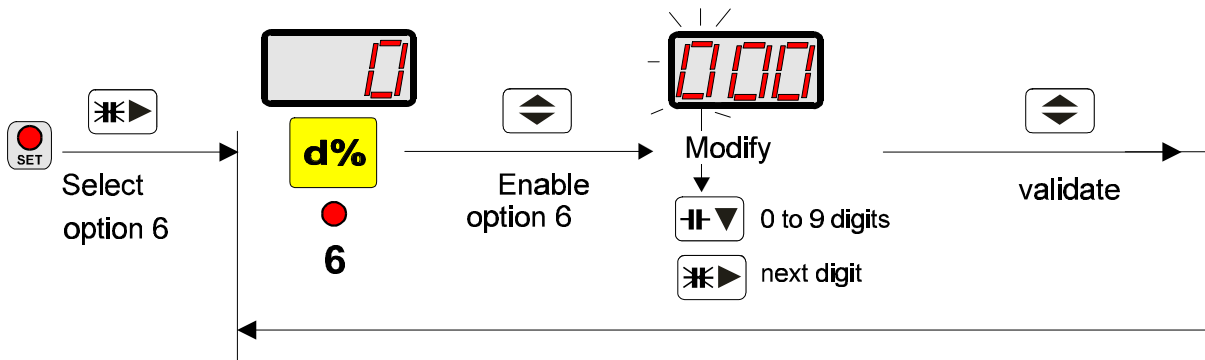
The value of the previously set choice is shown on display, and the first digit blinks.



c.- Use keys  and  to modify the value on display:

- Repeatedly pressing the key  the value of the blinking digit is increased.



- Press the key  to pass to next digit.

d.- Press  to exit this menu option and to validate modifications General SET-UP menu is again accessed.

5.7.- CONNECTION TIME



Set here the delay time between the connection of automatic bank steps. This is an user-programmable value from **0,1 s to 9,99 s**

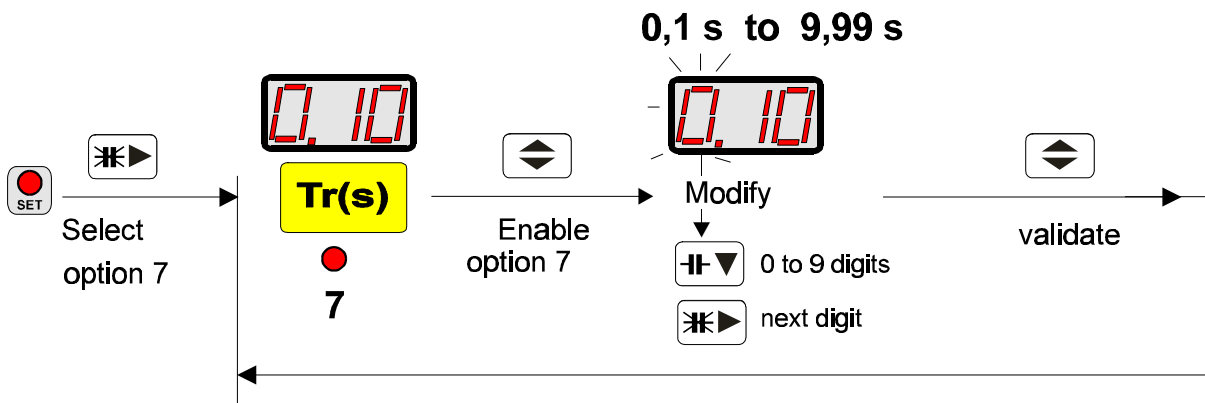

Once in setup mode (the led "set", red coloured, is always on) :

- a.- Use the key  to place at position 7: the led "7" is on
- b.- Use the key  to enable **connection time in seconds setting**

The value of the previously set choice is shown on display, and the first digit blinks.



- c.- Use keys  and  to modify the value on display:



- Repeatedly pressing the key  the value of the blinking digit is increased.
- Press the key  to pass to next digit.

- d.- Press  to exit this menu option and to validate modifications General SET-UP menu is again accessed.

5.8.- RECONNECTION – SAFETY TIME



Set here the delay time for the reconnection of a same capacitor in the automatic bank (safety time). This is an user-programmable value from **0,1 s to 9,99 s**.

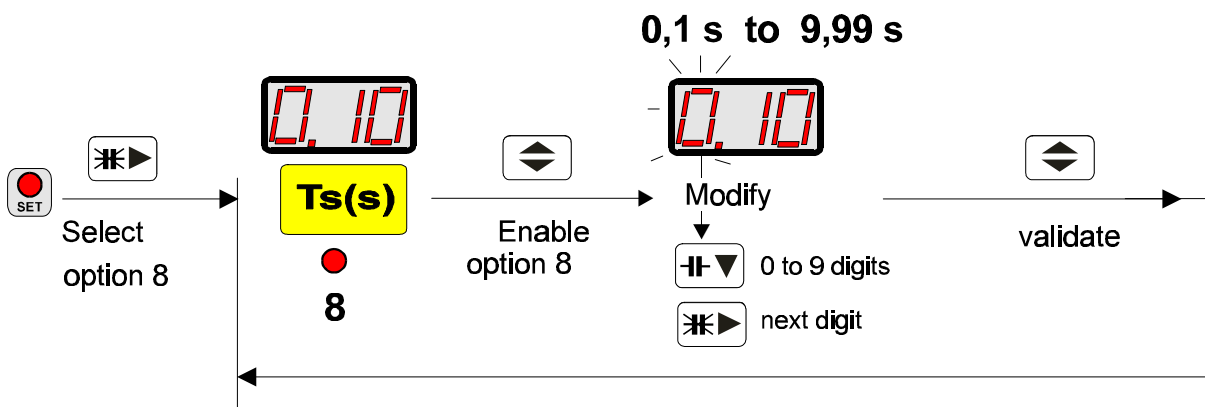

Once in setup mode (the led "set", red coloured, is always on) :

- a.- Use the key  to place at position 8: the led "8" is on.
- b.- Use the key  to enable **safety time in seconds setting**

The value of the previously set choice is shown on display, and the first digit blinks.



- c.- Use keys  and  to modify the value on display:



- Repeatedly pressing the key  the value of the blinking digit is increased.
- Press the key  to pass to next digit.

- d.- Press  to exit this menu option and to validate modifications General SET-UP menu is again accessed.

5.9.- NUMBER OF CAPACITORS SETTING:



When entering this set-up option, the number of capacitor is shown on display, as well as related leds are on.

Use this option to set the number of outputs used in the regulator. This is an user-programmable value from **1 to 8 outputs**.

- a.- Use the key  to place at position **No**: only the led "set" is on.
- b.- Use the key  to enable **number of outputs**

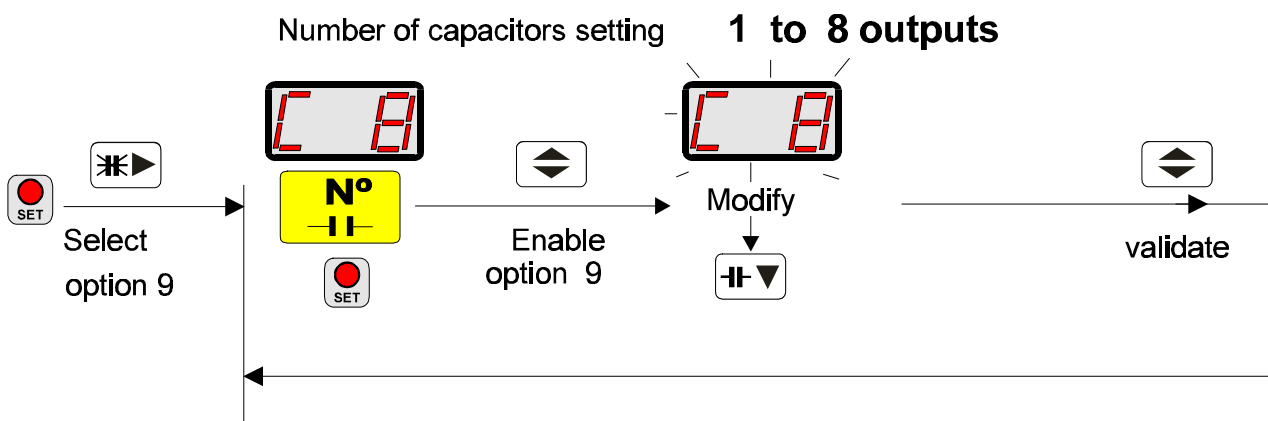
The value of the previously set choice is shown on display:



- c.- Use keys  and  to modify the value on display:

- Repeatedly pressing the key  the number of relays changes along C-1 C-8, and related leds are on.

- d.- Press  to exit this menu option and to validate modifications General SET-UP menu is again accessed.

6.- ALARMS

The regulator is equipped with diverse alarms that will trip whether following conditions are met:

Alarm type	Indication on display	Alarm description
Ineffective power factor correction	"- C.E" (Correction Error)	- Alarm condition is met when a reactive power two time higher than the set unit power is being measured during more than 100 seconds. The alarm led (H) is then on and the displays shows the message "- C.E". - Time considered for this alarm starts when all programmed relays are on and a higher demand is detected, or when all relays are off and capacitive power is still in excess.
Distortion alarm d %	"- d.E " (Distortion Error)	- This alarm trips when user-defined alarm conditions occur during at least 10 seconds. When this alarm is activated, the regulator successive switch off steps until alarm conditions are not met anymore. - For a set value of 0, this alarm is disable.
Overcurrent alarm	"- A.E" (A error)	- This alarm trips when an overload higher than 5.8 A is detected at the current input during at least 10 seconds.
Overvoltage alarm	"- U.E" (Voltage error)	- This alarm instantaneously trips when an overvoltage is detected at the regulator power supply.

For all above cases, the **alarm led (H)** is on, and the related message is shown on display to indicate the alarm type.

Whether the regulator is also provided with an alarm relay (according to the model), such relay is an independent and switch-over (terminals 10 ,11 & 12) type one. When the regulator is powered and no alarm condition is met, such contacts switch (10-11 closed and 11-12 open).

NOTE : When any key is pressed, the alarm message is not shown on display. Whether alarm conditions are still met, the message will appear up again 2 minutes later.

7.- INTERNAL PERFORMANCE OF THE FCP SYSTEM

With data received from the external circuit (voltage and current), the regulator calculates the phase angle and the capacitor value necessary to reach the pre-set target $\cos \phi$. Once this value has been obtained, the FCP system takes the decision to switch on appropriate steps.

In case that, for instance, the operation program is 1.2.2, the regulator will decide, according to the reactive demand, whether the most convenient decision is to connect the first step or directly to switch on a double-power one (this system avoid unnecessary switching operations of the first step) thus increasing the life span of the whole power factor correction unit.

Besides, in order to get a uniform wear of the automatic bank, the FCP system keeps in memory the time each capacitor remains switched off, so that when a capacitor is required to be connected, this capacitor will be the one switched off for the longest time.

A safety system avoids a capacitor to be re-connected if the user-defined safety time (T_s) has not passed yet.

Example :Required switching operation for a 100 % demand from zero for a regulator set at 6 steps.

STANDARD SYSTEM

Steps	1	2	2	2	2	2
1°	x					
2°		x				
3°	x	x				
4°		x	x			
5°	x	x	x			
6°		x	x	x		
7°	x	x	x	x		
8°		x	x	x	x	
9°	x	x	x	x	x	
10°		x	x	x	x	x
11°	x	x	x	x	x	x

Total number of operations = 16

FCP System

Steps	1	2	2	2	2	2
1°		x				
2°		x	x			
3°		x	x	x		
4°		x	x	x	x	
5°		x	x	x	x	x
6°	x	x	x	x	x	x

Total number of operations = 6

8.- TECHNICAL FEATURES

Supply voltage :	230 / 400 V a.c.  other voltages on request
Voltage circuit : Tolerance Burden Frequency	+ 15 % / - 15 % 5 VA 45 ... 65 Hz
Current circuit : Rated current Permanent overload Short-time overload Burden	Isolated In / 5 A a.c. 2 x In (alarm signal due to overcurrent at 5.8 A) 5 x In during 10 s 0,5 VA
Control system	FCP
Cos φ setting	0,80 ind 0,95 Cap.
Cos φ visualization	By display - 3 digits
Operation programs	1:1:1:1 / 1:2:2:2 / 1:2:4:4 / 1:2:4:8 / 1:1:2:2
Outputs	8 static optocoupled outputs
Connection time Tr	0,1 to 9,99 s (user-programmable)
Safety time Ts	0,1 to 9,99 s (user-programmable)
Output Alarm relay : Maximum voltage Ui Thermal current Ith AC11 Ie / Ue DC11 Ie / Ue Mechanic endurance Electric endurance	400 V a.c. / 250 V d.c. 10 A 4 A / 250 V a.c. 1 A / 110 V c.c. 3 · 10 ⁷ operations 2 · 10 ⁵ operations (full load)
Safety	Installation class III, as per EN 61010. Protection against electric shock by double isolation system (class II equipment)
Environmental conditions Working temperature Maximum relative humidity	-10° to +50 °C 95 % no-condensation

<p>Mechanic characteristics : Connection Case material Protection class External dimensions Net weight</p>	<p>Through plug-in connection terminal Self-extinguishing, V0, plastic Assembled instrument (frontal) : IP 54 Not-assembled instrument (side and rear plates): IP 31 COMPUTER-8df-144 : 144 x 144 mm - depth : 100 mm COMPUTER-8df-96 : 96 x 96 mm - depth : 100 mm 0.520 kg</p>
<p>Standards :</p>	<p>EN 61010, EN 61000-3-2, EN 61000-3-3, EN 50081-2, EN 50082-1, EN 50082-2, EN 61000-4-2, EN 61000-4-4, EN 61000-4-8, EN 61000-4-5, EN 61000-4-11 , UL 94,</p>
<p>Codes :</p>	<p>code 1 11 ***</p>

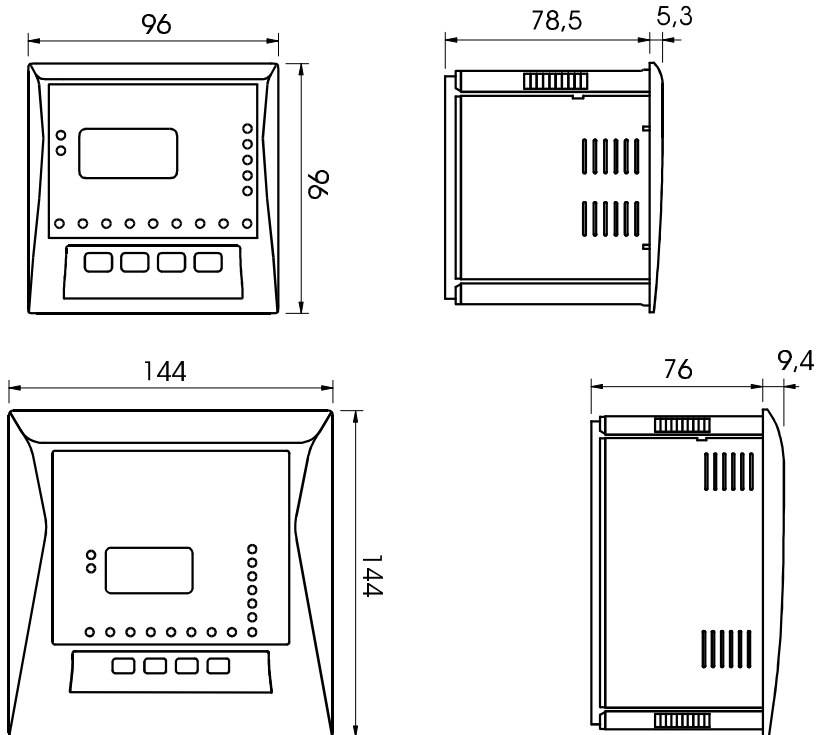



9.- SAFETY WARNINGS

The user should take into account all installation instructions referred in sections related with INSTALLATION AND STARTUP, CONNECTION INSTRUCTIONS and TECHNICAL FEATURES of the regulator.

Note that with the instrument powered on, the terminals could be dangerous to touching, and cover opening or elements removal actions may allow accessing dangerous parts. The regulator is factory-shipped in proper conditions.

10.- MAINTENANCE

The **Computer 8df** does not require any special maintenance. No adjustment, maintenance or repairing actions should be done over the instrument open and, should those are essential, high-qualified operators must perform them.

Before any adjustment, replacement, maintenance or repairing operation is carried out, the instrument must be disconnected from any power supply source. When any protection failure is suspected to exist, the instrument must be immediately put out of service. The own instrument design permits a quick replacement in case of damage.

11.- TECHNICAL SERVICE

For any inquiry about the instrument operation mode or in case of malfunction, you can contact CIRCUTOR S.A.'s technical service.

CIRCUTOR S.A. - Aftersales Service
Lepanto, 49
08223 - TERRASSA (SPAIN)
Telephone: + 34 - 93 - 745 29 00
FAX: + 34 - 93 - 745 29 14 / + 34 - 93 - 745 29 13
E-Mail: central@circutor.es